

Wireless World

Radio • Electronics • Electro-Acoustics

33rd YEAR OF PUBLICATION

OCTOBER 1943

Proprietors :
ILIFFE & SONS LTD.

Managing Editor :
HUGH S. POCOCK,
M.I.E.E.

Editor :
H. F. SMITH.

Editorial, Advertising
and Publishing Offices :

DORSET HOUSE,
STAMFORD STREET,
LONDON, S.E.1.

Telephone :
Waterloo 3333 (35 lines).

Telegrams :
"Ethaworld, Sedist, London."



PUBLISHED
MONTHLY

Price : 1/6

(Publication date 25th
of preceding month)

Subscription Rate :
Home and Abroad
20/- per annum.

EDITORIAL. Wireless "Jargon"	287
MULTI-PURPOSE TEST METER. By R. F. Blackwell, B.Sc., and D. G. Becker ..	288
WIRELESS BADGES	293
LONG-DISTANCE SHORT-WAVE TRANSMISSION. By T. W. Bennington	297
"WIRELESS WORLD" BRAINS TRUST ..	301
SUNSPOTS	303
RADIO DATA CHARTS.—No. 11 : Frequency and Wavelength. By J. McG. Sowerby, B.A., Grad.I.E.E.	304
USE OF VALVES (concluded) By J. R. Hughes, A.M.I.E.E.	306
UNBIASED. By Free Grid	310
WORLD OF WIRELESS	311
LETTERS TO THE EDITOR	313
RANDOM RADIATIONS. By "Diallist"	316
RECENT INVENTIONS	318

Branch Offices :

COVENTRY :
8-10, Corporation Street.
Telephone : Coventry 5210.
Telegrams :
"Autocar, Coventry."

BIRMINGHAM :
Guildhall Buildings,
Navigation Street, 2.
Telephone :
Midland 2971 (5 lines).
Telegrams :
"Autopress, Birmingham."

MANCHESTER :
260, Deansgate, 3.
Telephone :
Blackfriars 4412 (4 lines).
Telegrams :
"Iliffe, Manchester."

GLASGOW :
26B, Renfield Street, C.2.
Telephone : Central 4857.
Telegrams : "Iliffe, Glasgow."



As many of the circuits and apparatus described in these pages are covered by patents, readers are advised, before making use of them, to satisfy themselves that they would not be infringing patents.

"HYPERLOY"

TRANSFORMERS AND CHOKES

A range of high-performance, space-saving Components designed to meet the most exacting requirements of modern Electronic and Communications equipments.

- Small in size
- Weighing only 2 oz.
- Meeting the most rigid Tropical Specification
- Easily mounted in any position
- Manufactured in a variety of windings to meet many diverse applications

★ Owing to wartime restrictions on supply of raw materials, it is not possible to supply Wearite Components for purposes other than those connected directly with the war effort.

WRIGHT & WEAIRE LTD.

HIGH ROAD, TOTTENHAM, N.17

Telephone : TOTtenham 3847-8-9



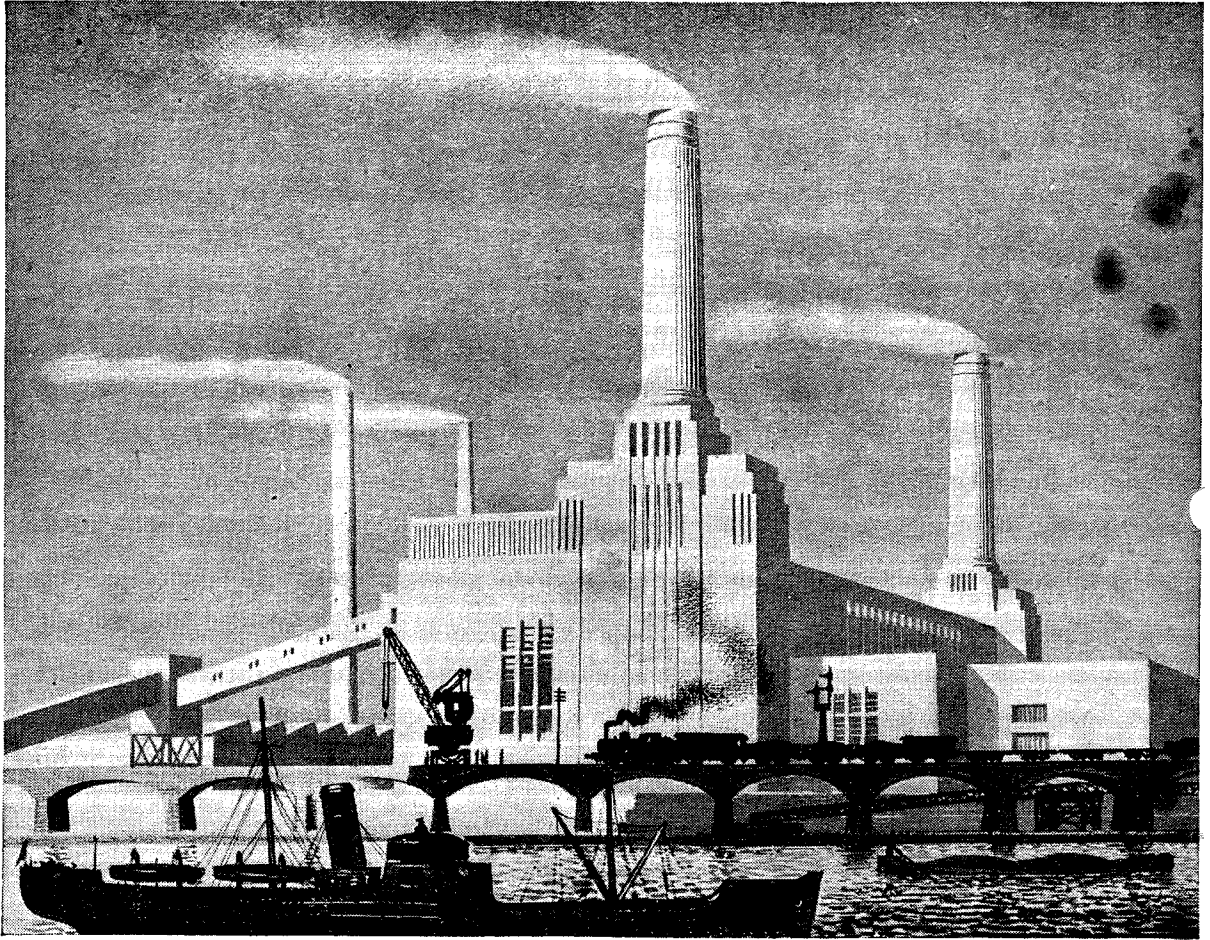

Valves and Chimneys

White vapour issuing from industrial chimney-stacks is a sign of an efficient combustion system; black smoke indicates incomplete combustion, and shows that fuel is going to waste.

Many industrial concerns now make use of an electronic device consisting of an arrangement of valves and a light sensitive cell, which is capable

of giving a record of smoke density, or of regulating the combustion process to ensure maximum efficiency.

This is another example of the ever-increasing usefulness of the thermionic valve—not only contributing to greater industrial efficiency, but also foreshadowing far-reaching benefits to the community.

MULLARD

THE MASTER VALVE

A Valve for Every Purpose

DOMESTIC · COMMERCIAL · INDUSTRIAL · SCIENTIFIC · MEDICAL · EXPERIMENTAL

THE MULLARD WIRELESS SERVICE CO. LTD., CENTURY HOUSE, SHAFTESBURY AVENUE, LONDON, W.C.2. (58)

Wireless World

Radio • Electronics • Electro-Acoustics

Vol. XLIX. No. 10

OCTOBER 1943

Price 1s. 6d.

Wireless "Jargon"

Avoiding Misleading and Unintelligible Terms

IN every rapidly developing art there is a risk that the terminology peculiar to that art will get out of hand; the hastily coined words and phrases used to describe new things and processes will lack aptness, intelligibility and elegance. That has happened more than once during the spectacular growth of wireless, particularly during the period of rapid expansion of broadcasting. One of the best—or the worst—examples of the phraseology of that period is the expression "all-mains," used to denote a broadcast receiver or other piece of apparatus that functioned without batteries of any kind. Some time before the war we reported a court case where it was ruled that the buyer of a set so described was entitled to expect something that would work on any kind of mains supply. One can imagine that the learned judge, after giving the ruling, muttered to himself, "That should show these wireless people that they must be more careful with their jargon." This legal ruling ran contrary to generally accepted usage in wireless circles, but few will deny that "all-mains" was, to say the least, an ambiguous description.

At the present time, intensive development of certain wireless techniques is going on "in the back rooms" under conditions that are likely to prove a forcing ground for the evolution of an undesirable jargon. When the developments concerned come out into the open, the new terminology may well be unintelligible, not only to the layman but also to technicians outside the inner circle. We plead with those responsible for the coining and standardising of additions to the vocabulary of wireless to take some thought for the future, and to realise that a hastily adopted word or expression that is misleading or ambiguous may all too easily pass into the language and cause endless confusion and misunderstanding in later years.

One of the aims to strive for, when dealing with matters likely to come within the ken of layman, is to use words that will be understood by both layman and technician. It is not always necessary to have two languages, one for the inner circle and

the other for the rest. Above all, one should avoid using existing words in a sense that runs contrary to the accepted usage of the language.

Another principle is that no new expression should be coined unless we are certain that it is necessary. An example of something to be avoided is to be found in "video" and "viseo," applied to television in a mistaken attempt to match up with "radio" and "audio" in the designation of frequencies. Fortunately, most of us were content to speak of "vision frequency," and the coined words never had a very wide currency.

Corrupting Our Vocabulary

Apart from the question of misleading, inapt or unnecessary new expressions, care should be taken that the meaning of clearly defined existing words of our vocabulary is not corrupted. The B.B.C. should be particularly careful to set a good example when it has occasion to refer to the means by which it distributes its programmes. Perhaps, now that we have a wireless engineer as Deputy Director-General, to say nothing of an ex-wireless man as Editor-in-Chief, we shall no longer hear announcers say, "Howard Marshall, *broadcasting to us* from Algiers . . ." One does not "broadcast" to an individual, or even to a great Corporation, in spite of the fact that one may be using a broadcasting station temporarily for point-to-point transmission.

In these matters we do not presume to set up as arbiters of taste, or to impose on contributors or correspondents a rigidly standardised technical vocabulary. It has always been the policy of *Wireless World* to conform with what it judged to be the best usage, only avoiding widely accepted expressions when they seemed to be misleading or ambiguous. In any case, complete standardisation of our terminology is quite impossible; it is always growing and under constant revision to keep pace with new developments. Given a little care on the part of those who can exert influence on the choice of words, this natural process of growth seems preferable to attempts at rigid control.

MULTI-PURPOSE TEST METER

Mains-operated Instrument Measuring
RF and AF Voltage, DC and AC
Voltage, and Current, and Resistance

By

R. F. BLACKWELL, B.Sc., and D. J. BECKER

(Murphy Radio, Ltd.)

MUCH routine work in the radio laboratory consists of DC and AC voltage and current measurements, rough checking of resistance, and measurement of RF and AF voltage. A unit was built covering all the above requirements, and as commercial instruments are difficult to obtain it was thought that a description of it would be of interest.

The ranges covered are:—

Voltage, DC and AC: 0-10, 0-100, 0-500, 0-1,000 volts.

Current, DC: 0-1, 0-10, 0-100 mA, 0-1, 0-10 amps.

Current, AC: 0-10, 0-100mA, 0-1 amp.

Resistance: 0-10,000 ohms, 0-1 megohm.

Valve Voltmeter, RF and AF: 0-1, 0-10, 0-100 volts.

Valve Voltmeter, DC: 0-5, 0-50, 0-500 volts.

A 1mA meter is used for all measurements. There are two scales, the lower graduated for resistance ranges and the upper divided linearly and numbered 0-5 and 0-10 for all other ranges.

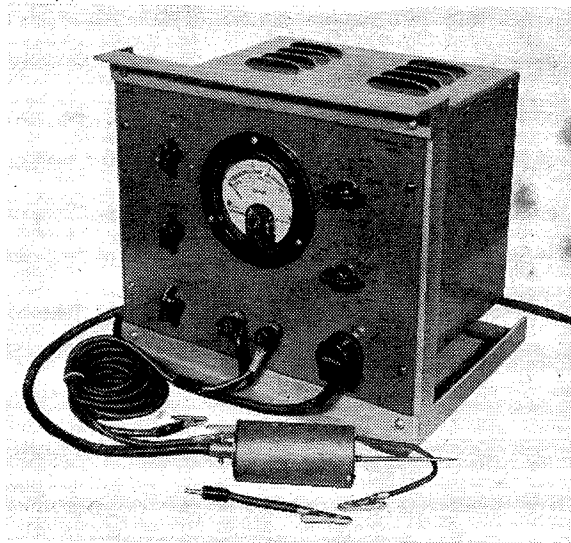
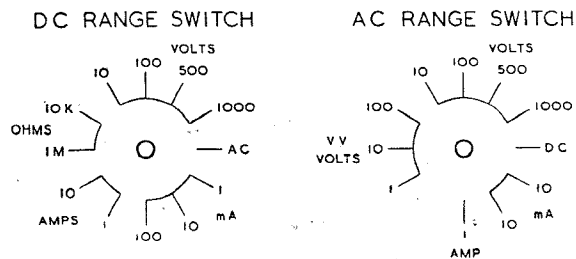

Front view of test meter showing range switches and zero setting controls.

volt. In Fig. 2 (a), if V volts produce full-scale deflection, and the resistance of the meter movement is r ohms, the required series resistance, R ohms, is given by $R = 1,000 V - r$.

In the meter used, r is 118 ohms and can be neglected on all ranges except perhaps the lowest.

DC Current Meter.—The meter movement alone is used for the 1mA range; for 10mA a shunt resistance of value $r/9$ ohms is switched across the meter and on the 100mA and higher ranges a tapped shunt is used (see Fig. 2 (b)). The advantage of this method

The 10mA range shunt resistance has a value of 13.1 ohms, and is made up of 1 yard of 36 SWG DSC Eureka. Fig. 3 (a) gives dimensions of a suggested former, and shows the method of twisting the tinned copper wire terminal tags.

The tapped shunt resistor R_1 consists of two 5in. lengths of 16 SWG bare Eureka in parallel, mounted on the switch wafer. The resistance is adjusted by running solder along the wire. R_2 (4½in. of 22 SWG DSC Eureka) and R_3 (12in. of 28 SWG DSC Eureka) are mounted on the same former (Fig. 3 (b)). These resistors should be adjusted by comparing the meter reading with that of an instrument that is known to be accurate, rather than adjusting to the calculated values. The lengths specified above are sufficient to allow for adjustment.

An abbreviated table of resistance wire constants is given on p. 290; more complete details* may be found in an earlier

Two twelve-position switches are used for selecting all ranges (see Fig. 1). The other controls are two zero-setters for the resistance ranges and one for the valve voltmeter.

DC Voltmeter.—As a 1mA movement is used, all ranges have a resistance of 1,000 ohms per

is that on the high-current ranges, accuracy of calibration is not affected by variations in switch contact resistance.

Resistance values are given by*:— $R_1 = r/9,900$; $R_2 = r/1,100$; $R_3 = r/110$.

In this case $r = 118$ ohms, hence, $R_1 = 0.012$ ohms; $R_2 = 0.108$ ohms; $R_3 = 1.08$ ohms.

Fig. 1. Arrangement of twelve-position range switches.

* A general formula (see Fig. 2 (c)) is

$$R_n = \frac{I_m \cdot i}{I_n(I_m - i)} \cdot r,$$

where m is the total number of ranges required on tapped shunt,

R_n ohms = resistance to tap for n th range,

I_m amps = current for full scale deflection on lowest range,

I_n amps = current for full scale deflection on n th range,

i amps = full scale deflection current of meter,

r ohms = resistance of meter.

† "Designing Resistances," by R. F. Blackwell, *Wireless World*, July, 1941.

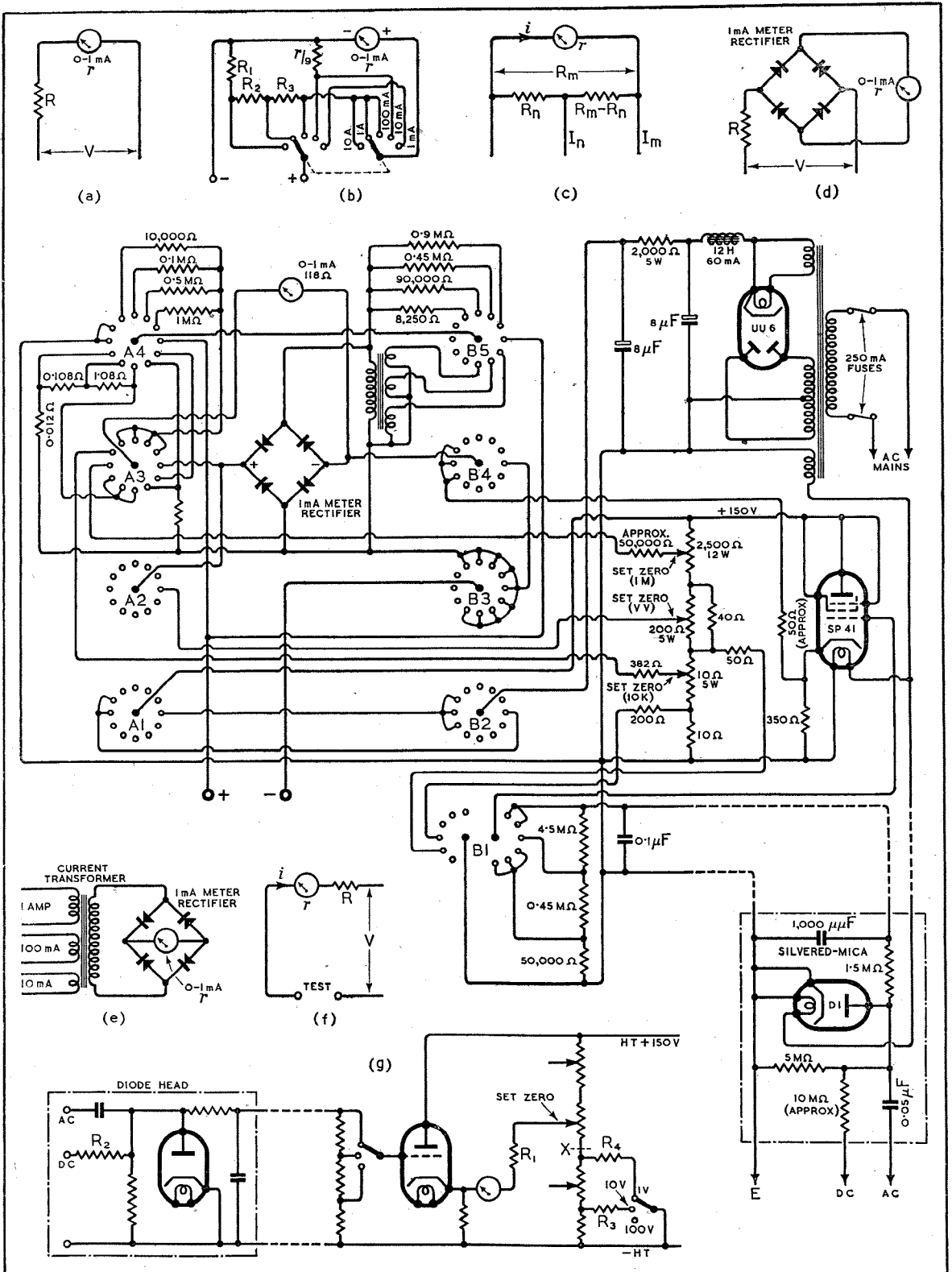

Fig. 2. Complete circuit of test meter and schematic diagrams showing basic circuits for various functions

Multi-purpose Test Meter—

article. The resistance of Eureka wire may differ by as much as 10 per cent. from the values shown in the table. The figures given are also substantially correct for Constantan.

AC Voltmeter.—A Westinghouse 1mA meter rectifier is used (see Fig. 2 (d)). The DC current output from this type of meter

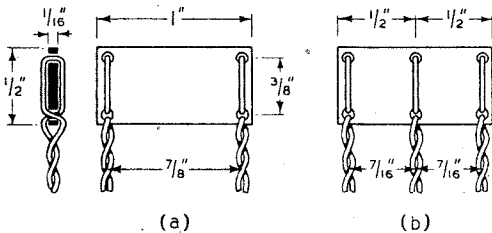

Fig. 3. Current meter shunt formers.

rectifier is proportional to the mean value of AC input. For a sinusoidal waveform, on which most measurements are made, RMS value = 1.11 × mean value. From the manufacturer's data, the p.d. across the AC terminals of a 1mA rectifier is 0.9 volt, for a meter current of 1mA. Hence, the series resistance R ohms required for V volts RMS full-scale deflection is

$$R = \frac{V - 0.9}{0.001} \times \frac{1}{1.11} = \frac{1,000V - 900}{1.11} \text{ ohms.}$$

Therefore, R for 10 volts full scale deflection = 8,250 ohms,

R for 100 volts full scale deflection = 90,000 ohms,

R for 500 volts full scale deflection = 450,000 ohms,

R for 1,000 volts full scale deflection = 900,000 ohms.

The 0-10 volt range should be EUREKA WIRE

SWG	Ohms per Yard	Current Rating*
16	0.21	6.0
18	0.37	4.3
20	0.66	3.0
22	1.09	2.2
24	1.77	1.5
26	2.65	1.00
28	3.91	0.76
30	5.58	0.59
32	7.35	0.47
34	10.1	0.37
36	14.8	0.28
38	23.8	0.19
40	37.2	0.15
42	53.6	0.13

* Amperes for 100° C. temperature rise, wire coiled in air with free radiation.

calibrated against an accurate meter, as the scale is non-linear due to the measured voltage being comparable with 0.9 volt, the p.d. across the rectifier. From the maker's data, the output of the rectifier is uniform for frequencies up to 100 kc/s.

AC Current Meter.—A current transformer is used in conjunction with the meter rectifier (Fig. 2 (e)). The ranges covered are 0-10 mA, 0-100 mA and 0-1 amp.

As a current of 1.11 mA is required from the secondary to give full scale deflection on the meter, the turns ratios, not allowing for losses, are as follows:—

1 amp. range, ratio = 1,000/1.11 : 1 = 900 : 1,

100 mA range, ratio = 100/1.11 : 1 = 90 : 1,

10 mA range, ratio = 10/1.11 : 1 = 9 : 1.

For linear scale-shape, the voltage drop in the secondary winding should not be more than 0.1 volt. Hence the maximum permissible resistance of the secondary is 0.1/1.11 × 10⁻³ = 90 ohms. To keep the secondary turns as low as possible a single turn primary winding is used on the 1-amp. range; thus the secondary turns are 900. To keep losses low the stampings must be made of a high-permeability material, such as Mumetal; a set of Mumeta stampings was available with the following dimensions:—

- Core, 3/4 in. square,
- Overall size of stamping, 1 7/8 in. × 2 1/4 in.,
- Winding area, 1 in. long by 0.3 in. deep,

Weight of set of stampings, 3/4 lb. It was found that, to allow for iron loss, the secondary turns should be reduced to 880; 38 SWG ESS (enamelled and single silk) copper is used for the secondary, giving a resistance of 70 ohms. The primary windings are:—

10 mA range, 100 turns 38 SWG Enam or ESS,

100 mA range, 10 turns 28 SWG Enam or ESS,
1-amp. range, 1 turn 20 SWG Enam.

The secondary is wound on first and the other windings in the order shown above. There are two layers of Empire tape between the secondary and the primaries and one layer between each primary. The stampings are interleaved.

Fig. 4 shows the frequency characteristic of the transformer on the 10 mA range.

Ohmmeter.—There are two ranges, covering resistance values from 10 ohms to 1 megohm. The fundamental circuit is shown in Fig. 2 (f).

If the meter, of which the resistance and full scale deflection are r ohms and i mA respectively, is connected in series with a resistance of value R ohms across a voltage V, then, for full scale deflection (with "Test" terminals shorted)

$$R + r = 1,000V/i \dots (1)$$

If now a resistance R' ohms is connected across "Test," then its value for half scale deflection of the meter is given by

$$R' + R + r = 1,000V/0.5i \dots (2)$$

From equations (1) and (2),

$$R = R' - r$$

$$\text{and } V = iR' \times 10^{-3}.$$

In this instrument, r = 118 ohms, i = 1 mA and the mid-scale readings are 500 ohms and 50,000 ohms; hence the values of R are 382 and 49,900 ohms respectively; the corresponding values of V are 10.5 and 50 volts. These voltages

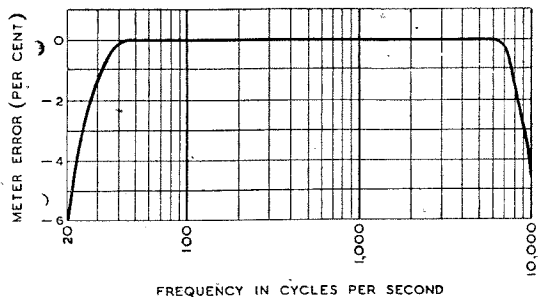

Fig. 4. Frequency characteristic of AC current meter.

are supplied from a mains-operated power pack by means of a voltage divider network, the tappings being variable over a small range to provide zero-ohms adjustment. The internal resistance of the supply should be small compared with (R + r);

in this case, the internal resistances are 15 and 700 ohms respectively.

Valve Voltmeter.—A high-frequency diode rectifier of small dimensions (Mazda D1*) is housed with its associated smoothing components in a cylindrical container; this is connected to the main instrument through about a yard of 3-core cable. A 5-pin Belling-Lee plug and socket are used for the connection on the front panel, but it would be

of the control valve, the value of which depends on the setting of the range switch. This would necessitate resetting the zero when the range is changed. This is automatically compensated for by shunting the lower end of the power pack voltage-divider by R_3 on the 10v. AC and 50v. DC ranges, and R_4 on the 1v. AC and 5v. DC ranges.

The DC ranges were originally the same as the AC (0-1, 0-10, 0-100 volts) but trouble was ex-

perienced when the valve voltmeter was connected across a low-resistance circuit, as this reduced the standing bias due to the diode, thus altering the zero setting. The simplest method of eliminating this effect is to use a

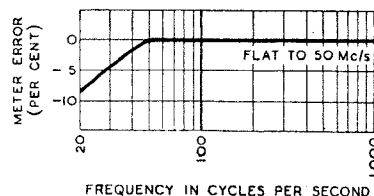

Fig. 5. Frequency characteristic of valve voltmeter.

perienced when the valve voltmeter was connected across a low-resistance circuit, as this reduced the standing bias due to the diode, thus altering the zero setting. The simplest method of eliminating this effect is to use a

divider with the diode load and therefore reduces sensitivity. R_2 is chosen to give ranges to fit in with the calibrated scale, viz. 0-5, 0-50, 0-500 volts.

As the input resistance on the DC ranges is high, approximately 13 megohms, the shunting effect on a high resistance source of voltage is small.

In high-resistance circuits it is advisable to measure only voltages of which the positive side is earthy; if the negative side of the source is earthy, the leakage resistance and capacitance of the HT line to the chassis are shunted across the source, as the negative side must be connected to the "live" lead of the valve voltmeter.

The 10- and 100-volt AC, and 50- and 500-volt DC ranges are substantially linear, and no further calibration is required. For greatest accuracy on the 1-volt AC and the 5-volt DC ranges separate calibrations should be

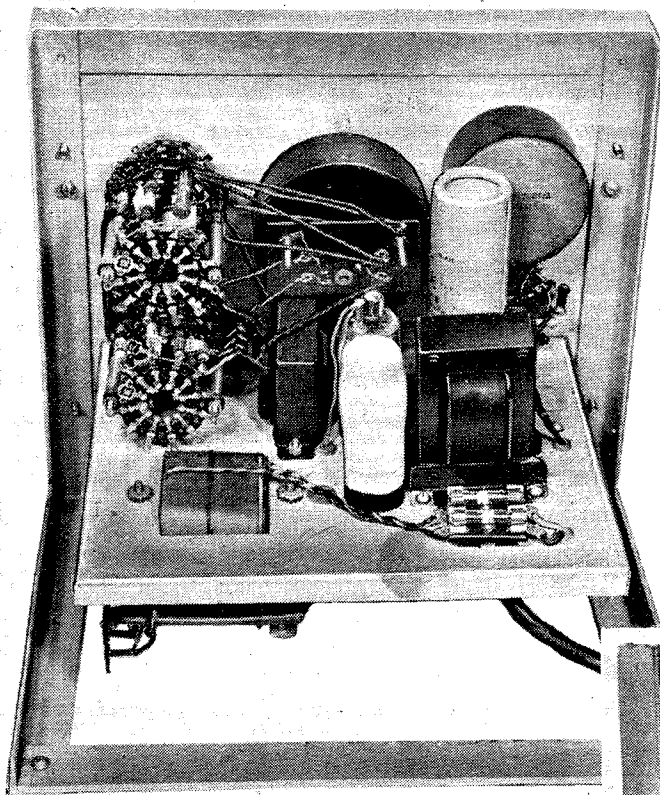

sufficient to run the cable through a bush.

The rectified voltage from the diode head is applied to a meter control valve, the supply voltages for which are taken from the power pack. A potential-divider circuit across the HT supply voltage is used to "back-off" the meter (Fig. 2 (g)). The range is changed by tapping-down the diode load resistance. The standing current through the diode produces a small voltage across this resistance; this voltage applies a negative bias to the grid

*A similar valve is the Mullard EA50, which has a 6.3-volt heater.

Back views with cover removed showing components above and below the horizontal sub-panel.

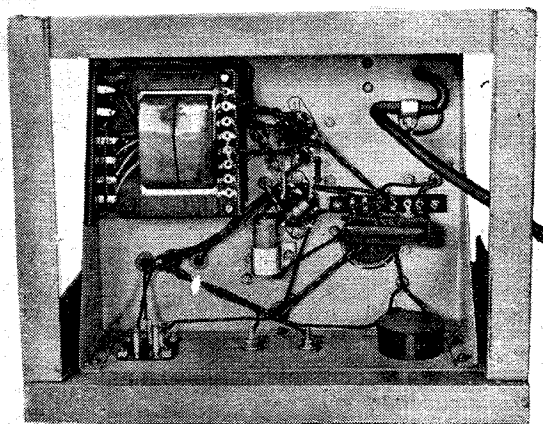

made; this is due to the non-linear characteristic of the diode.

The frequency characteristic is flat between 50 c/s and 50 Mc/s (see Fig. 5). It was not measured above 50 Mc/s, but the error is

Multi-purpose Test Meter—

probably small up to at least 100 Mc/s.

The meter control valve is an SP41 (high-slope RF pentode) connected as a triode. Two other types were tried: the HL41 (medium-slope triode)—approximately 5 per cent. loss in sensitivity, which can be compensated for by reducing the meter series resistance R_1 (Fig. 2 (g)); the P41 (high-slope triode)—sensitivity as the HL41, but in this case a 70 ohm resistance must be inserted at the point X in the voltage-divider circuit of Fig. 2 (g) to enable the zero to be set. Differences in sensitivity between individual specimens of these types were small, in all cases it was possible to allow for this by adjusting the meter series resistance R_1 (Fig. 2g). The following valves would probably be suitable: 41MHL, AC2HL, 354V, MH4, HL4G, EF50 and Z62.

The following table gives some idea of the working conditions of the valves:

	SP41	HL41	P41
Anode current (mA)	4.2	5.0	12.2
Anode voltage ..	146	148	138
Cathode voltage ..	1.6	1.9	4.8

All measurements were made on the 0-iv. AC range, with the meter set to read zero.

If a voltage much larger than full scale is applied to the input, the current through the 1 mA meter does not exceed about

2 mA; most meters can withstand this overload without harm.

The input capacitance of the diode head is 7.5 $\mu\mu\text{F}$ with a short flexible lead and 6.5 $\mu\mu\text{F}$ with a rigid prod.

Adjustment of resistors is carried out as follows:—

(1) Meter series resistance R_1 to give iv. full scale deflection on most sensitive AC range.

(2) Input resistance R_2 to give 5v. full scale deflection on most sensitive DC range.

(3) Compensating resistances R_3 and R_4 adjusted so that the zero-setting does not change on the 10v. and iv. AC ranges respectively when switching from the 100v. range.

Power Pack.—The power requirements are 4v. 1.4A for the rectifier heater (UU6), 4v. 1.5A for the SP41 and D1 heaters and 150 volts 50 mA DC for the valve voltmeter and ohmmeter sections.

A standard type of mains transformer was available, with two 4-volt windings and an HT winding of 350-0-350 volts. It is necessary to reduce the rectified HT voltage by means of a series resistor. A more suitable HT secondary voltage would be 250-0-250, which, with a choke input filter, would give the required voltage without the series resistance. The choke must be capable of withstanding a high AC voltage across its terminals. A 150-0-150 volt winding with a condenser input filter would be equally suitable.

Switching.—The complete circuit is shown in Fig. 2. It will be seen that there are two switch-wafer banks, A and B, A consisting of four single-pole, 12-way units and B of one two-pole 6-way and four single-pole 12-way units. A1 and B1 are mounted nearest the front panel. A3, A4, B4, B5 switch the various ranges, A1, A2, B2, B3 ensure that the HT supply voltage to the valve voltmeter and ohmmeter is switched on only in certain positions, and B1 selects the valve voltmeter ranges and switches the valve voltmeter set zero compensating circuit.

Constructional Notes.—The chassis is fixed to a vertical frame-mounted front panel. The front panel is 9in. by 12in. and the chassis 8in. by 10in. A detachable cover is held by two screws on the vertical frame members; examination of the photographs will make clear the layout details.

The diode head consists of two discs of insulating material of diameter 1 $\frac{1}{8}$ in. held together by two $\frac{3}{16}$ in. brass pillars, 3in. long. A length of paxolin tube slides over this assembly, and is fixed by screws into the insulating discs. One of the discs has two wander-plug sockets, one for AC, the other for DC; either a flexible lead or a rigid prod can be plugged into these sockets, according to the type of work in hand. The earth connection is a permanent short flexible lead terminating in a crocodile clip, which can conveniently be attached to the nearest part of the chassis.

The 0.05 μF diode input coupling condenser should have a high resistance and a low inductance; the tubular type with wire ends fits best into the small space available. It should be remembered that the working voltage of the condenser must be high enough to withstand the DC component when measuring an RF voltage at the anode of a valve. The condenser leads are as short as possible, and thus it is connected directly between the AC input socket and the diode anode clip.

In conclusion, we wish to express our thanks to Mr. E. A. Goldring, for the photographic illustrations, and to Murphy Radio, Ltd., for permission to describe this apparatus.

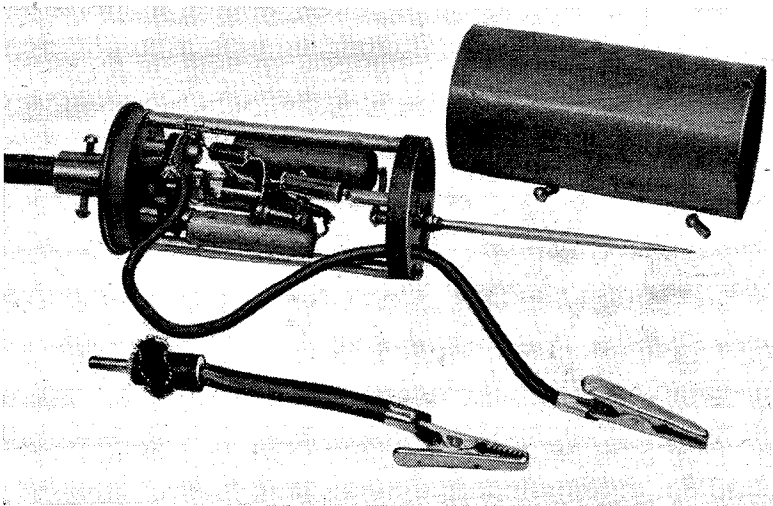

Valve voltmeter head with cover removed.

WIRELESS BADGES

Radio Insignia in the Forces

Among the many wireless badges worn by members of the British and American Forces, there are some not quite so well known as the easily recognisable R.A.F. "Sparks" or "Hand and Lightning" badge; moreover, on enquiry at the War Office, it was learned that a number of the emblems seen in some of the shops "supplying everything for the sailor, soldier and airman" are unauthorised and should not be worn by members of the Forces. It is, therefore, with the intention of facilitating the recognition of wireless personnel and of giving some facts about the duties of the wearers of wireless badges that these notes have been prepared.

ROYAL NAVY

IN the Senior Service there are a number of different categories of Wireless Telegraphist. The badge for each of these is based on the same design, with additional stars or a crown to in-

Telegraphists and Telegraphists (not trained operators) wear badge (a) in the accompanying illustration. These are the junior ratings in the W/T Branch of the Royal Navy.

Trained Operators (W/T) wear badge (b) and are, as the rating infers, telegraphists who are trained to operate the W/T gear in general use on H.M. Ships.

Wireless Telegraphists 3rd Class wear badge (c), and have a higher standard of technical training. They have to be well versed in the complexities of Naval wireless procedure and may be the senior W/T rating in small ships.

Badge (d) is worn by Wireless Telegraphists 2nd Class (ratings below Petty Officer) who are in many cases the senior W/T ratings in destroyers, etc.

Wireless Telegraphists 2nd Class (Chief Petty Officer and Petty

Officer Telegraphists) wear badge (e) and are usually the senior W/T ratings in large destroyers (Tribal Class), cruisers, etc.

There are comparatively few Wireless Telegraphists 1st Class (f). They are Chief Petty Officer Telegraphists, Petty Officer Telegraphists and Leading Telegraph-

ists of not less than four years' seniority. First Class C.P.O. Tels. and P.O. Tels. usually serve in Flag Ships and Capital Ships. In the case of C.P.O.s the badge is worn on the lapels of their jackets.

NAVAL AIR ARM

THE maintenance of Naval air-borne radio equipment is the duty of the wireless ratings in the Naval Air Arm.

Radio Mechanics in the Naval Air Arm, who wear a peaked cap with red badge, and jacket with the distinguishing badge on the right sleeve, serve in aircraft carriers and in Naval Air Stations at home or abroad. A Radio Mechanic in the Naval Air Arm may be attached either to a squadron, for the maintenance of the squadron's equipment, or to a carrier or station for general radio maintenance duties.

On satisfactorily completing their technical and Service training, ratings in this branch are advanced to Leading Radio Mechanic and subsequently are eligible, if proficient, for advancement to the rating of Acting Petty Officer, Petty Officer and Chief Petty Officer.

The actual operation of Naval

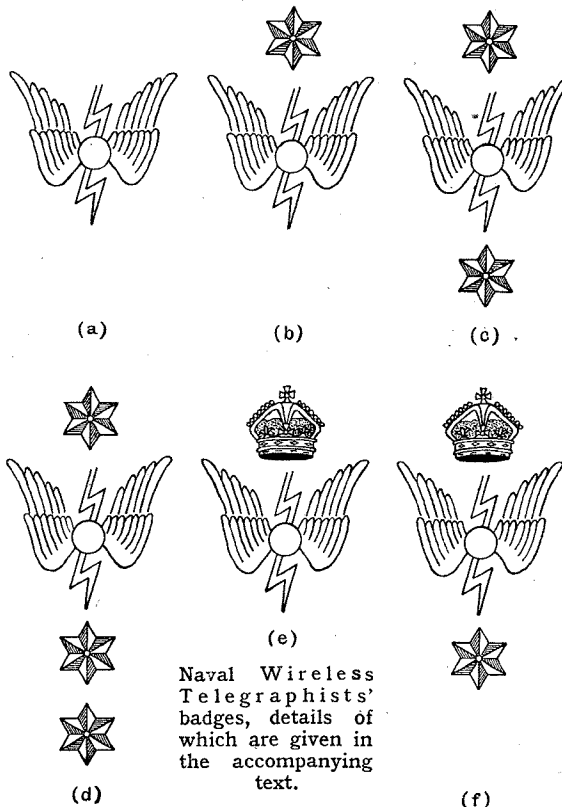

Naval Wireless Telegraphists' badges, details of which are given in the accompanying text.

dicating the wearer's non-substantive rating. Embroidered in red on a navy blue background for working dress but in gold for No. 1 dress, the badges, with the exception of that for Chief Petty Officer Wireless Telegraphist, are worn on the right arm.

Boy Telegraphists, Ordinary

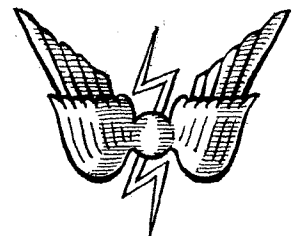

Naval Air Arm Radio Mechanic's badge.

Wireless World

Wireless Badges—

airborne radio equipment is normally carried out by the Observer or by the Telegraphist Air Gunner of the aircrew except in single-seater fighters, where, of course, the pilot operates his own equipment. Nearly all Observers are now officers who, in common with all Naval Air Arm officers, are distinguished by the letter "A" worn in the curl of the officer's gold lace on each cuff, while on the left sleeve is worn the Observer's badge. The Tele-



Badge worn above the gold "distinction" lace by Observer officers of the Naval Air Arm.

graphist Air Gunner wears the seaman's class of uniform and has on his right arm the distinguishing badge illustrated below.

As in all branches of the Navy, Leading ratings wear a single "foul anchor" and Petty Officer ratings crossed "foul anchors" surmounted by a crown on the left sleeve. Chief Petty Officers do not normally

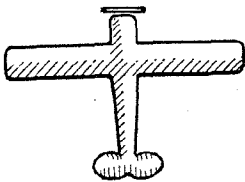

Telegraphist Air Gunner's badge.

wear sleeve badges but have on each lapel the badge of their branch and three gilt buttons on the cuff of each sleeve.

W.R.N.S.

IN the women's branch of the Senior Service there are two radio categories, viz., Wireless Telegraphists and Radio Mechanics. Both these categories wear the same design of badge on

the right arm; it is identical for Petty Officers, Leading Wrens and Wrens. In the case of Chief Wrens a smaller badge with a crown above the wings is worn on each side of the collar of the jacket.



Wren Wireless Telegraphists operate, and to some extent maintain, communication apparatus at Naval shore stations in this country and oversea.

Radio Mechanics, a compara-

ble at present worn by Chief Wren Wireless Telegraphists on the collar of their jackets. The design is light blue with red inset in the crown.

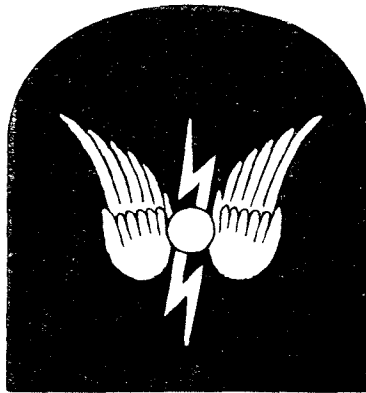

Petty Officers, Leading Wrens and Wren Wireless Telegraphists and Radio Mechanics wear this light blue embroidered sleeve badge.

tively new W.R.N.S. category, maintain and repair radio apparatus.

ROYAL SIGNALS

NO distinctive badge is worn by wireless personnel in the Royal Corps of Signals. It is, however, the "wireless corps," and it is, therefore, appropriate that the badge of the corps is reproduced in this collection of wireless emblems.

The well-known figure of Mercury—the messenger of the gods—standing on a globe is a fitting symbol for the Corps, the motto of which is "Certa Cito" (Sure and Swift). Formed in 1920, the

Corps' task is to maintain the Army's lines of communication, which include wireless, through-



The badge of Royal Signals.

out the widely dispersed fields of operation.

The distinguishing flash of the Corps is blue and white.

R.E.M.E.

THE formation of the Corps of Royal Electrical and Mechanical Engineers a year ago has brought together in one corps the wireless personnel that were previously in various units of the Army (with the exception of Royal Signals personnel).

There are two badges worn by R.E.M.E. personnel who are responsible for the maintenance of telecommunications apparatus, which includes radar, wireless and line equipment.

Armament Artificers (Radio) and Radio Mechanics, who repair

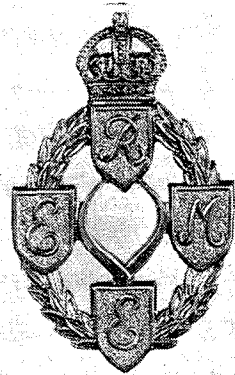

R.E.M.E. badge.

and maintain radar apparatus, wear a red embroidered wireless flash on a navy blue background.

Armament Artificers (Wireless) and Wireless Mechanics, who are responsible for the maintenance and repair of wireless and line communication apparatus, wear a badge of similar design to that worn by Radio Mechanics, but embroidered in white.

Both badges are worn on the right arm; in the case of Warrant Officers on the forearm below the rank badge, by N.C.O.s above the rank chevrons and by other ranks on the upper arm below the formation sign, etc.

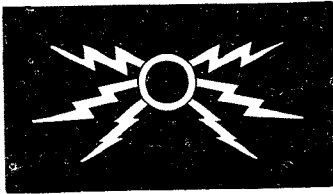

The design of the two R.E.M.E. wireless badges.

A.T.S.

MANY members of the Women's Auxiliary Territorial Service (A.T.S.) will be seen wearing the badge of Royal Signals above the left breast pocket of their tunics. These Auxiliaries are attached to the Corps, and may be carrying out the same duties as the men Operators, Wireless and Line. This means that they must have a certain amount of technical knowledge and be qualified morse operators. They are known colloquially as "OWLS."

Members of the A.T.S. attached to R.E.M.E., who have passed the requisite trade tests for Radio Mechanic or Wireless Mechanic wear the same badge as men of the same category.

R.A.F. AND W.A.A.F.

THE well-known "Hand and Lightning" badge is the only trade arm badge worn in the

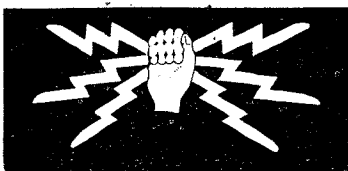

R.A.F. "Spark's" badge. A light blue design on a background of Air Force blue.

Royal Air Force and Women's Auxiliary Air Force, and is common to all signal trades. Air

Radio Observer's brevet. The wing and letters are in silver and the laurel in brown.



crews and ground staff concerned with the operation and maintenance of radar and communication apparatus wear this distinctive badge on the right upper arm. Wireless Operators in air crews are usually Air Gunners, and, therefore, wear the A.G. brevet over the left breast pocket.

A badge less frequently seen worn by members of the R.A.F. is the Radio Observer's brevet. This is worn above the left breast pocket by commissioned and non-commissioned officers of air crews who handle the UHF gear. Although the R.O. brevet has been superseded by the navigator's "N" brevet, men who qualified for it in the past are still permitted to wear it.

MERCHANT NAVY

THERE are three classes of Radio Officer in the Merchant Navy and they are distinguished

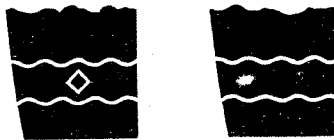

(a) (b)

Merchant Navy Radio Officers' Distinction Lace. (a) First Radio Officers, (b) Second, and (c) Third.



(c)

by waved lines of gold braid worn on the cuffs of their jackets. The standard Merchant Navy cap badge is worn by Radio Officers.

First Radio Officers wear two lines of 1/4 in. gold braid with a diamond between them. In the case of Second Radio Officers the diamond is omitted, whilst Third

Radio Officers wear one band only.

AIRWAYS

ALTHOUGH not in the Forces, it is perhaps permissible to include in this survey of wireless heraldry the insignia worn by Radio Officers in the employ of British Overseas Airways. They wear the cap badge of the Corporation and a wing over the left breast pocket, as do all the members of air crews. Their rank is distinguished by waved bands of



(a) (b)

Waved lines of gold braid worn by First (a), Second (b) and Third (c) Radio Officers of British Overseas Airways.



(c)

gold braid worn on the cuffs of their blue jackets.

First Radio Officers wear three lines of braid, Second Officers—two, and Third Officers—one.

U.S. NAVY

THERE is one design of badge for the three radio categories in the Artificer Branch of the United States Navy.

Radiomen operate standard naval transmitting and receiving equipment, maintain and care for radio batteries and adjust and repair DF apparatus and sound equipment. Enciphering and de-

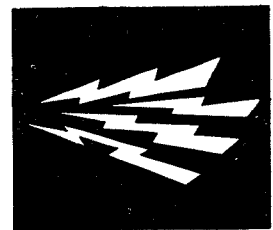

Radiomen, Radio Technicians and Telegraphers in the U.S. Navy wear this badge.

ciphering is also undertaken by Radiomen.

The general maintenance of

Wireless Badges—

radio equipment in the U.S. Navy is the duty of another category, that of Radio Technician.

A category authorised only in time of war is that of Telegrapher. Men of this grade are telegraph

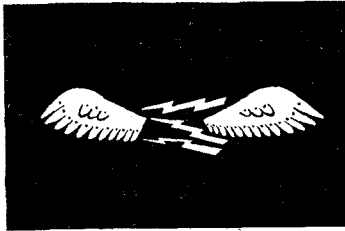

Radiomen in the Aviation Branch of the U.S. Navy are identified by this badge.

operators at Naval cable stations.

There is one radio category in the Aviation Branch, which is equivalent to the British Naval Air Arm. Designated Aviation Radiomen, their qualifications are very similar to their counterparts in the Artificer Branch. Their duties are, however, mainly associated with aircraft radio equipment.

In each of the above specialist grades there are four ratings: 3rd Class, 2nd Class, 1st Class and Chief. The radio badge is worn by each grade between the American eagle and chevrons on the left sleeve. The number of chevrons indicates the rating; one being worn by 3rd Class, two by 2nd Class, and three by 1st Class and Chief ratings. In the case of the latter a fourth semi-circular braid surmounts the chevrons.

U.S. SIGNAL CORPS

LIKE our own Royal Signals, the United States Signal Corps is responsible for the Army's communication systems and, in addition, for ground com-

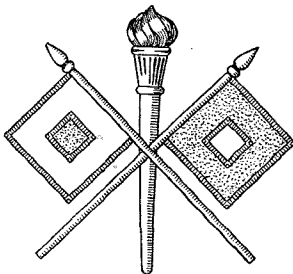

U.S. Signal Corps badge. The flags are enamelled red (shown stippled) and white for officers.

Wireless World

munications of the U.S. Army Air Force. Many members of the Corps are now in this country and can be recognised by the Corps' distinguishing badge of crossed signalling flags. The badge is gilt and is worn on the lapels of their jackets.

U.S. ARMY AIR FORCE

RADIO operators in U.S. Air Crews do not wear a distinctive badge. The metal wings they wear above the left breast tunic pocket are the same as those worn by all N.C.O. combat crew men.

Of the ten members of a Fortress crew four normally hold commissions—pilot, co-pilot, navigator and bombardier—whilst the remainder, including the radio operator, are sergeants.

It is perhaps noteworthy that men of the U.S. Air Force crews who are currently engaged in operations wear a patch of blue cloth behind the metal wings.

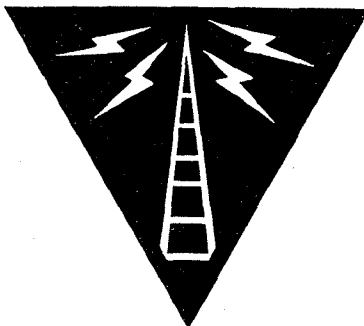

Communications Technician's badge.

A badge that is not very common but might be seen in theatres of operation in which there are units of the U.S. Army Air Force, is that shown above. Civilian communications technicians attached to the Air Force wear this gold emblem symbolising radio on a blue triangular base on the sleeve of their service uniforms. The wearer is a specialist who, because of physical disability, age, or the importance of his civil occupation, cannot be called to the colours and is, therefore, temporarily attached to the Air Force.

SERVICE-MEN'S EXAM.

IN last month's *Wireless World* a draft syllabus of the examination to be conducted by the Radio Trades Examination Board was published. Since then, the Board has made slight modifications and

added a few extra subjects; the final syllabus is printed below.

The first examination will be held on Saturday, May 20th, 1944, and thereafter in May of each year. It will be conducted in principal technical schools throughout Great Britain, and will comprise a three-hour written paper and a three-hour practical test.

Candidates must have been fully engaged in wireless service work for not less than three years, but a full-time course in servicing or radio engineering at a recognised technical school will count as one year towards the required period. The examination fee is two guineas.

The Secretary of the Board (address: 9, Bedford Square, London, W.C.1) will be pleased to give any further information required.

Part 1.—Fundamental Principles of Radio.—(1) Current/voltage relationships in AC and DC circuits. (2) Primary and secondary cells. (3) Theory of magnetism; magnetic screening. (4) Laws of induction; mutual and self-inductance. (5) Electrostatics; electrostatic screening. (6) Resonance; series and parallel resonant circuits. (7) Modulation, methods of. (8) Thermionic valves. (9) Rectifiers; rectification and detection. (10) Electro-magnetic waves; simple wave theory. (11) Aerials and transmission lines. (12) Amplifiers and oscillators. (13) Receiver circuit practice. (14) Reproducers and pick-ups.

Part 2.—Practical Applications.—(1) Principles and uses of test meters; resistors; rating and coding. (2) Primary and secondary cells; tests; charging; battery charging plants. (3) Permanent and electro-magnets, and their uses. (4) Transformers; RF, IF, AF and mains. (5) Condensers, fixed and variable. (6) Tuned circuits and alignment. (7) Diode, triode, tetrode, pentode and frequency-changing valves; gas-filled types. (8) Copper-oxide and selenium rectifiers; methods of rectification; simple filters. (9) Receiver power supplies; battery, mains, AC/DC, rotary and vibratory converters. (10) Wave propagation; interference and its suppression. (11) Aerial and earth installation; coupling devices. (12) RF, IF, and AF amplifier circuits; degeneration and regeneration; negative feed-back; oscillators; distortion and instability. (13) Sound amplification and relay practice; methods of mixing; reflexed circuits. (14) Receivers; TRF, super-sonic heterodyne and super-regenerative. (15) Automatic gain control; tuning indicators; automatic frequency control; automatic tuning devices. (16) Tone control and correction circuits; noise suppression circuits. (17) Loudspeakers, microphones and gramophone pick-ups; methods of matching. (18) Practical safety precautions.

Part 3.—Practical Examination.—(1) Soldering technique. (2) Use and maintenance of test equipment and tools. (3) Valve testing (HT, LT and GB batteries supplied). (4) Correction of typical receiver faults, which may include realignment (circuit diagrams, chassis layouts and oscillators supplied). (5) Testing components. (6) Loudspeaker and pick-up adjustment

Long-distance

SHORT-WAVE TRANSMISSION

Simplified Explanation of the Behaviour of Obliquely Incident Waves

By T. W. BENNINGTON

IN a previous article¹ the behaviour of radio waves in the ionosphere was discussed in as simple language as possible, in the hope that such treatment of the subject would render some of its points understandable to the non-mathematical reader. The article confined itself almost exclusively to the behaviour of a wave when sent vertically upwards. Dr. Martin Johnson, in his July article² dealt with some of the more complicated phenomena in greater detail, while in a previous article³ he had something to say on the subjects of "refraction" and "total reflection" of radio waves.

A wave or "ray" of radio energy which is sent vertically upwards will, if it is of such a frequency as to be reflected from the ionosphere, return to earth at a point immediately beneath that where it is reflected. Rays which are intended to return to earth at points far distant from the transmitter must go upwards obliquely, so as to enter the ionosphere at a smaller angle to its lower boundary than did the vertical ray. It is the purpose of this article to explain—so far as is possible in the same simple language as was used in the former article—how the behaviour of the wave in the ionosphere is modified by the obliquity of its upward path.

Let us, first of all, recall one or two points appertaining to the behaviour of the vertically travelling ray. We remember that it travels through the ordinary air towards the ionosphere with a velocity of 300,000,000 metres per second, but, on entering the region where the air is "ionised," its

wave velocity increases. But because the ionosphere is what Dr. Martin Johnson calls a "dispersive" medium, i.e. because its effects upon the wave vary with the wave frequency, the signal as a whole travels *slower* in the ionosphere than in ordinary air—its "group velocity" is less. Eventually it comes to a complete stop, is "reflected" and then sent travelling downwards again. As we increase the frequency of the wave the effect of the ionosphere upon it gets less and less, so that it penetrates further and further into the region before undergoing "reflection." Continuing to increase the frequency eventually results in the wave penetrating the ionosphere altogether, and the frequency just below that at which the penetration of any ionosphere

much for the vertical ray. Let us now digress for a moment and consider some points from what—so far as the obliquely travelling radio ray is concerned—is a closely analogous case, i.e. the behaviour of a ray of light when it passes from a dense into a less dense medium. Those who have done any school "physics" may recognise the diagram of Fig. 1; it illustrates what happens to the light ray under these conditions. So long as it is moving through a uniform medium, light travels in a straight line, but as soon as it enters a medium of different optical density it is deflected from the straight path and continues on in a new direction; the phenomenon is known as "refraction."

In Fig. 1 the shaded area represents the dense medium and the unshaded area that which is less dense, while AB is the surface of separation between the two. A line drawn at right angles to this surface—as at CD—is called the "normal" to this surface or boundary. IO is the light ray approaching the surface obliquely so as to reach O—the point of "incidence"—at an angle to the normal. The angle which it makes with the normal at the point of incidence is called the "angle of incidence." Instead of continuing its course in a straight line in the new medium—as shown by the dotted line—the ray is refracted or bent, so as to travel along the line OQ, and it is because the new medium is less dense than the other that the direction of the bending is *away* from the normal. The angle made with the normal in the new medium is called the "angle of refraction." The *amount* of bending to which the ray is subject will depend on the relation between the densities of the two

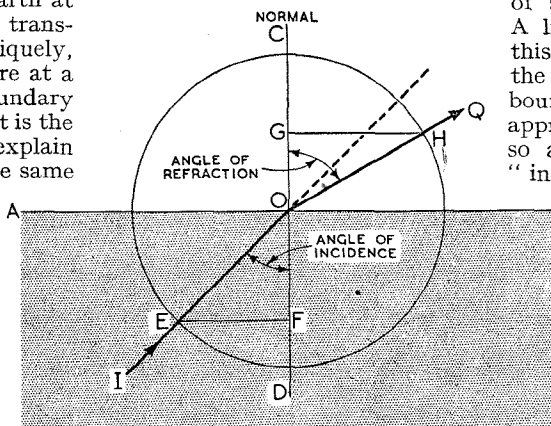

Fig. 1. What happens to a light ray passing from one medium to another.

layer occurs is called the "critical" frequency of that layer. This critical frequency, then, is the highest frequency which is returned by the ionosphere for a wave sent vertically upwards.

Refraction of a light ray.—So

¹ "Radio Waves in the Ionosphere," *Wireless World*, April, 1943.

² "Waves in Metals and the Ionosphere," *Wireless World*, July, 1943.

³ "Waves in Dielectric Materials," *Wireless World*, June, 1943.

Short-wave Transmission—

media, and, if we compare the angle of refraction with the angle of incidence, we shall obviously obtain some information on this point. Suppose we describe a circle about the point of incidence and then drop perpendiculars to the normal from the points where it cuts the incident and refracted rays—as at EF and GH in Fig. 1—then the ratio of EF to GH is a measure of the bending to which the ray has been subject, and hence of the relative densities of the two media. This ratio is called the “refractive index,” and a little thought will show that, if we consider this ratio as the

Fig. 2. How “total reflection” is obtained by increasing the angle of incidence of the ray.

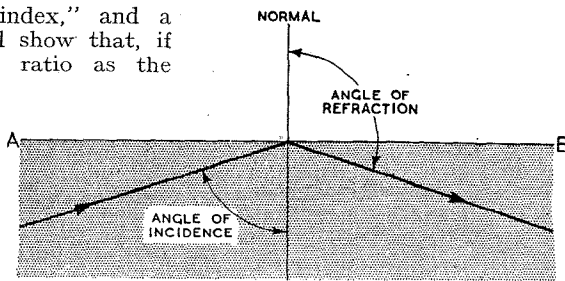

refractive index of the less dense medium, then it will always be less than unity. The relation between the angle of incidence and the angle of refraction is such that the sine of the angle of incidence is equal to the sine of the angle of refraction multiplied by the refractive index.

If we increase the angle of incidence—by making the ray path more oblique—then the angle of refraction will increase also, and if this process is continued we eventually get an angle of refraction of 90° , when the path of the refracted ray is exactly along the surface of separation. A further increase in the angle of incidence leads to the result shown in Fig. 2. The angle of incidence has been so increased that the angle of refraction is *greater* than 90° —the light ray cannot penetrate into the new medium at all, but is “totally reflected” at its surface. This will occur when the sine of the angle of incidence is equal to the refractive index of the new medium—the sine of an angle of refraction of 90° being, of course, 1.0.

Rays of Radio Energy.—Now we can return to our ray of radio energy, which is approaching an ionosphere layer where it will undergo refraction in a somewhat similar manner to that in which

the light ray was deflected from its course.

It will be clear that there is, for a given height at which the ionosphere refracting layer may lie, a different angle at which the radio wave must enter the layer for every distance outwards from the transmitter. For a given layer height the greater the distance the greater will be this angle of incidence at the layer be. Also for a given distance, the lower the layer the greater will the angle be.

We have been talking about a “ray” of radio energy as though there were only one such ray to be considered. But we must always remember that in practical cases, even with an aerial system which narrows the radiated energy into a “beam” in the vertical plane, there will really be a whole “pencil” of such rays going up side by side, and making a number of different angles of incidence at the layer boundary.

Now such obliquely incident rays can be returned from the ionosphere with a far lower ionisation in the layer than is necessary to return a vertically incident ray. Or—another way of looking at it—with a given ionisation density in the layer the greater the angle of incidence the higher the frequency which will be refracted. The highest frequency which will be refracted so as to come down at any particular distance this depends on the critical frequency at vertical incidence and the angle of incidence appropriate to that distance. It is called the “maximum usable frequency” (MUF) for that distance.

The full theory concerning obliquely incident rays and relating the critical frequency at vertical incidence to the MUF at oblique incidence is very complicated, and we cannot go into it in any detail in this article. But we

can, perhaps, briefly consider its main implications.

Refraction of the Radio Ray.—Let us start off by supposing that both the earth and the ionosphere are flat. The ionosphere behaves to the radio ray entering it from ordinary air like the rare medium behaves to the light ray entering it from the dense medium. The wave path is bent away from the normal to the lower boundary of the ionosphere layer, so that the wave path makes a smaller angle with the lower boundary than it would have done had it not been refracted at the point of incidence.

The refracting properties of the layer upon the radio wave are due to the presence of the free electrons within it, and the electron concentration is not constant throughout the medium. Fig. 3 gives an idea as to how the electron concentration is assumed to vary with height in one of the ionosphere layers, and it will be seen that, looked at from the ground, it increases with height within the layer up to the point of maximum concentration, i.e. at the centre of the layer. So that

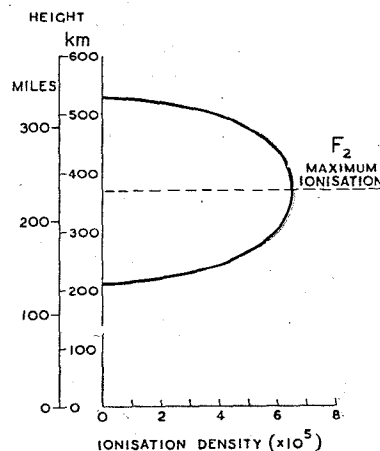

Fig. 3. How electron density varies with height in an ionosphere layer.

the refracting properties of the layer upon the radio wave constantly increase as the wave penetrates further into the layer.

Still imagining that the ionosphere is flat, let us try and sort things out so that the effect of this increasing free electron density upon the wave becomes clearer.

Suppose that, instead of increasing constantly with height, the electron density within the layer were itself in a series of thin "layers," as shown in Fig. 4, each thin "layer" having a constant electron density which was greater than that of the "layer" next

frequency at vertical incidence and the M.U.F. at oblique incidence it is best to look upon the ionosphere as having a refractive index which gets smaller as the electron density gets greater. The relation between the wave's angle of incidence and its angle of re-

the refracting layer lies. The MUF for a flat ionosphere is in fact equal to the critical frequency multiplied by the secant of the angle of incidence (the secant is 1.0 at 0 deg. and infinity at 90 deg.).

Fig. 4. Refraction of a wave by layers of increasing electron density.

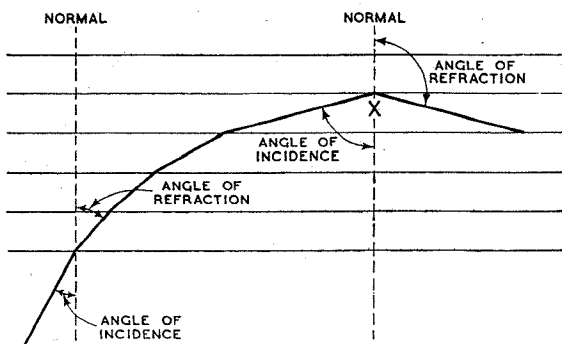

below it. Then we should get the effect shown in the figure—an effect similar to that shown by the light ray we have just been discussing. The radio ray would be refracted away from the normal each time it came to the boundary of one of the thin layers, and it is easily seen that its path would become more and more oblique until eventually the angle of refraction would exceed 90° and the ray would then start travelling downwards again. This occurs at the point X in Fig. 4.

fraction is the same as in the case of the light ray entering the rare medium; namely, that the sine of the angle of incidence is equal to the sine of the angle of refraction multiplied by the refractive index. So when the wave is at the top of its trajectory and the angle of refraction is thus 90 deg.—whose sine is 1.0—the angle of incidence is equal to the refractive index. The wave will therefore penetrate into the layer until the refractive index is reduced to a value equal to the sine of the angle of incidence, and will thereafter be travelling downwards again. This means that it must penetrate furthest into the layer when the angle of incidence is 0 deg. (vertical incidence) and least when it is 90 deg.

Effect of Ionosphere Curvature.

—The curvature of the ionosphere is responsible for some modification to this law. Because of the curvature the angle between the wave path and the thin "layers" of electron density which we used in our illustration would alter with increasing height. The result of this is that the wave path is completely turned round in a region where the refractive index is higher (the electron density is lower) than would be the case if the ionosphere were flat. There are other results of the curvature which we need not go into here, but, summing up its effect, it may be said: (a) That it results in higher frequencies being returned for any angle of incidence than would be the case if the ionosphere were flat; (b) the modification to the flat ionosphere case which it introduces is least when there is a thin, sharp reflecting layer of ionisation and greatest when the ionosphere gradient is low; i.e. when the electron density increases only slowly with height.

With the continuously increasing electron density that does in fact exist it means that the wave path is gradually bent round so that it travels in a wide sweep and thus eventually arrives at the lower surface of the ionosphere layer again, whence it continues in a straight line towards the ground. Perhaps a good way to picture the effect is to imagine that the top part of the wave as being further into the ionosphere than the bottom part, as is pictured in Fig. 5. Then, because it is in a region where the free electrons are denser, it travels with a greater velocity than does the bottom part of the wave. If the top of the wave travels faster than the bottom the wave direction cannot be in a straight line; but will bend away from the regions of high electron density to those where it is low, and the ray is therefore bent away from the normal to the lower boundary.

Fig. 5. Bending of the wave path within a refracting layer.

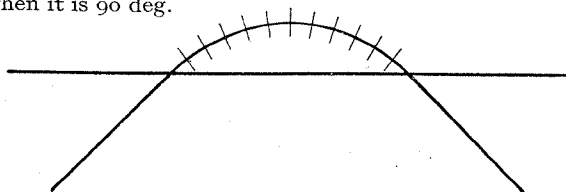

Thus with a given refractive index (given electron density) the wave will penetrate less and less far as the angle of incidence is increased, or, if it is allowed in each case to penetrate to the point of maximum electron density, then higher and higher frequencies can be used as the angle of incidence is increased. The MUF for any distance is this related to the critical frequency and to the angle of incidence occasioned by that distance and the height at which

In the curved ionosphere, then, the highest frequency returned (MUF) for a given maximum density of electrons in the layer will increase as the angle of inci-

dence is increased. This means firstly, that for a given set of ionosphere conditions of height and critical frequency the greater the distance the higher will be the MUF, and, secondly, because for a given distance the lower the layer the greater the angle of incidence, the lower the layer the higher the MUF for a given distance will be.

If, then, we know the critical frequency and virtual height of the layers—or have available

Short-wave Transmission—

predictions of what their values will be we can calculate the MUF appropriate to any distance by multiplying the critical frequency by a factor which has been worked out on the basis of the theory just mentioned. We can then work on this MUF or on any frequency below it, though we should endeavour to work as near to it as possible, because otherwise our wave will be heavily "absorbed" in the ionosphere. We must not work on a *higher* frequency than the MUF, for if we do the rays of energy, which we want to come down at the distance we are aiming at, will penetrate the layer and the location will fall within the skip distance (see Fig. 6).

Finding the MUF.—As has been said, the accurate calculation of the MUF is complicated, because of the complexity of the theory, but if we multiply the critical frequency by an MUF factor which is typical of the time of day and season of year this will be accurate enough for most purposes—it will at least enable us to estimate our working frequency with *some* degree of precision. This MUF factor will obviously be greater for the E layer than for the F, because of the greater height at which the latter lies. Also, for the F layer, it will vary considerably with time of day and season of year because the height at which the F lies varies diurnally and seasonally.

Table I is a set of typical MUF factors which was published some time ago by the National Bureau of Standards of Washington (with a few additional values inserted) and gives these for various distances, times of day and seasons, and for communication *via* differ-

ent layers. A little intelligent interpolation will yield values suitable for intermediate distances and for other seasons and times of day.

If, therefore, we have available

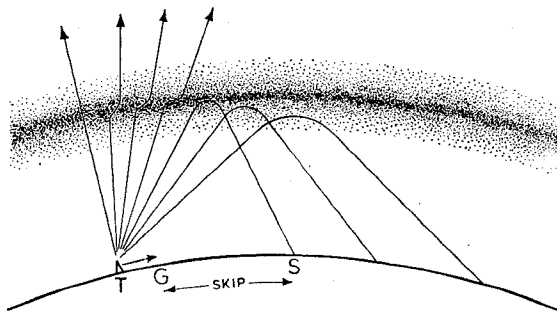

Fig. 6. The phenomenon of skip distance. T-G, range of ground wave; G-S, skip zone.

critical frequency data for each hour of the day, and we wish to find the MUF for any particular distance outwards from the transmitter, it is merely necessary to read off the critical frequency for the appropriate time at the *centre of the transmission path* and multiply it by the appropriate factor from the Table. Then we should work on the highest frequency available to us which is below the MUF, changing frequency to the next lower band when our frequency tends to exceed the MUF.

Effect of the E layer.—The maximum distance over which it is possible to transmit with a single hop is, on the average, about 2200 miles by the F or F2 layers and about 1250 miles by the E. Beyond 2200 miles the transmission will be by multiple hops and then the situation is somewhat more complicated, it being necessary to examine the whole transmission path, in order to find the lowest MUF which exists at any point over the path.

Transmission on short waves is

usually by way of the F or F2 layers, though we should always bear in mind the fact that if during the day we use a frequency far below the F2 MUF appropriate to the distance over which we

are transmitting, the wave may be refracted at the E, and not reach the F at all. During summer day, however, the E layer ionisation does reach a high enough value for the layer to "blot out" the F2 entirely for transmission at certain angles, during which time the E is the *controlling* layer for short-wave transmission. What this means is that, at the elevation angles for which it occurs, the E layer critical frequency and the angle of incidence the ray makes at the E *determine the MUF*, and any frequency which is high enough to penetrate the E at this elevation angle will also penetrate the F. It will not occur for the shortest distances because in this case the angle of incidence at the E is small and there is thus more tendency for a wave to penetrate the layer. Then at a certain angle it will occur and will continue out to the maximum distance possible for transmission by the E. Beyond this distance the F2 layer MUF will still continue to rise with increasing angle of incidence at that layer, and so the MUF is again controlled by the F2.

In calculating the MUF for any distance from the measured critical frequency by the use of such factors as those in Table I it is merely necessary, during the summer day, to multiply the critical frequency of each layer by the factor appropriate to the distance and layer. Then, whichever calculation yields the highest MUF indicates which of the layers will *control* the transmission over that distance.

TABLE I.—MUF FACTORS

	Transmission Distance in Miles						
	310	620	930	1250	1550	1850	2200
E layer	2.0	3.4	4.4	4.8	—	—	—
F layer							
<i>Winter:</i>							
Midnight	1.2	1.5	1.8	2.2	2.8	2.85	2.9
Noon	1.2	1.6	2.1	2.6	2.9	3.1	3.4
<i>Summer:</i>							
Midnight	1.2	1.4	1.7	2.1	2.5	2.7	2.8
Noon	1.2	1.5	1.8	2.2	2.5	2.8	2.9

Inspection . .

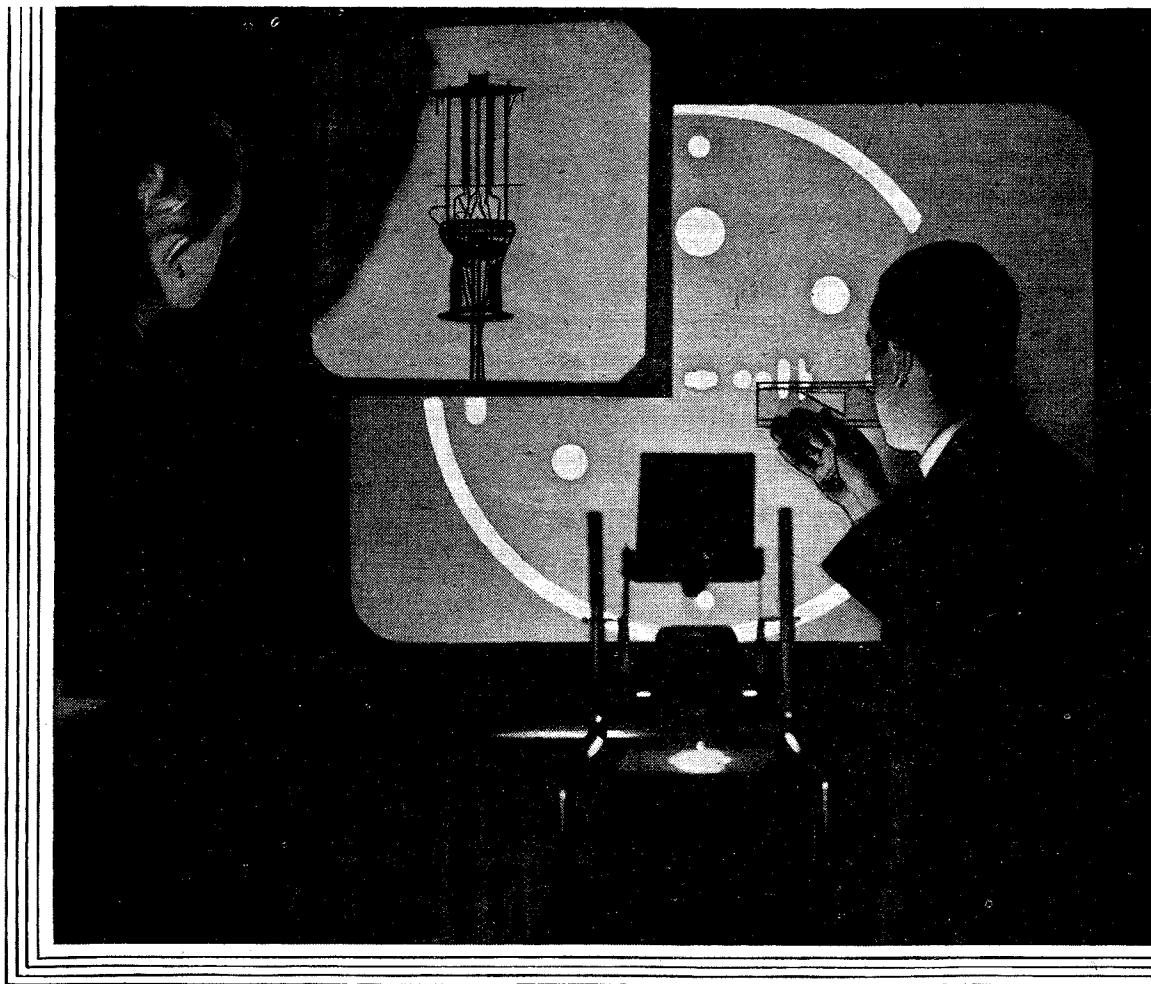

BY means of the epidiastroscope accurate and speedy inspection is facilitated. Our illustration shows greatly enlarged images of a top mica and partially assembled beam tetrode. Another example of the care which characterises every phase in the manufacture of Brimar Valves.

BRIMAR
BVA
VALVES

STANDARD TELEPHONES AND CABLES LIMITED, FOOTSCRAY, SIDCUP, KENT.

"to Insulate"

Practically all waxes are used to "separate or isolate," but the degree of insulation provided by the different types of waxes varies enormously.

There is obviously no higher degree of insulation required than that of electrical components and apparatus in intense electrical fields, especially in the extremes of conditions to which they are subjected to-day.

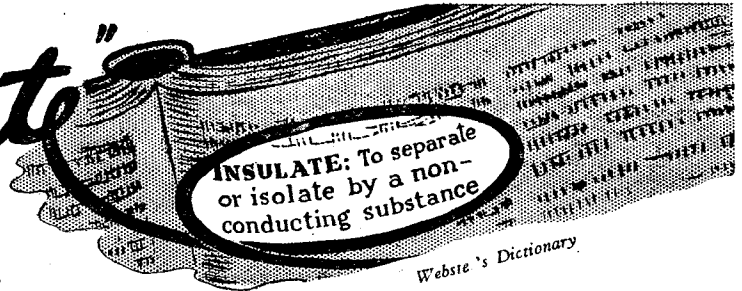

We specialise in the supply of
WAXES *for all*
purposes—under all conditions

Our technical advice is at your disposal.

If you have any problem of

IMPREGNATING—DIPPING—FILLING

we, as consultants to the Industry, shall be glad to offer you a solution.

CLAUD CAMPBELL & CO. LTD.

4, LLOYDS AVENUE—LONDON—E.C.3

Telephone Nos. :—ROYAL 5403/4/5.

Rotary Cutting, Filing, Grinding and Polishing—*Economy and Accuracy*

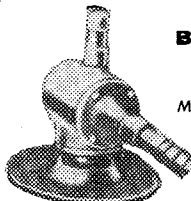
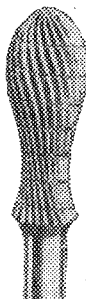
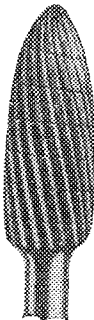
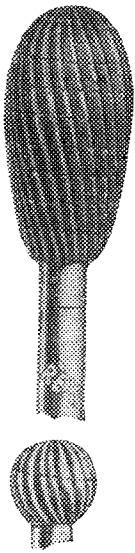

Use **MORRISFLEX** Flexible Shaft Equipment, and **REX** Rotary Files and Cutters for cutting, filing, grinding and polishing components of aluminium, Elektron, non-ferrous alloys and ferrous metals. For metal buffing and cleaning we supply **MORREX** Rotary Wire Brushes, and **MORRISFLEX** Rotary Polishing Mops and Felts, also Felt Cones. **MORRISFLEX** Rotary Rasps are ideal for woodworking, and attachments for **MORRISFLEX** machines include Sanders and Grinders.

MORRISFLEX machines are available in overhead suspension, bench and floor types. Their use ensures speed with accuracy, and a high degree of finish. Write for Lists.

B. O. MORRIS LTD.
 SHIRLEY,
 BIRMINGHAM.

Shirley 1237.

Grams :

Morrisflex, Birmingham.

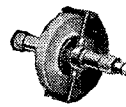
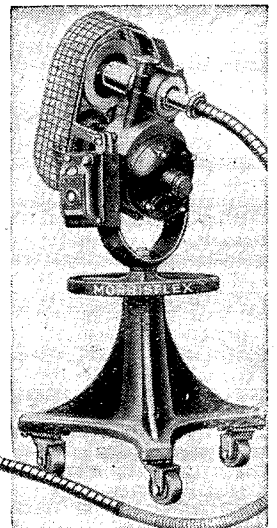

MORRISFLEX

FLEXIBLE SHAFT EQUIPMENT

Wired Broadcasting and Television. Standardised Voltages : Summing Up

MORE VIEWS ON QUESTION No. 12. Is wired broadcasting wanted and would it be in the best public interest to adopt it as the main means of distribution?

O. S. PUCKLE, best known for his work in the advancement of cathode-ray technique, considers this question largely in relation to the parallel problem of television distribution. He writes:—

BEFORE the question of wired broadcasting can be adequately discussed it is essential to have experience of a regular television transmission covering large areas of the country. We do not know what the public reaction to television will be: it may be that a television programme will replace one sound programme and not be required to be additional thereto. In any case few will deny that the television service must be installed before wire broadcasting policies are decided upon.

With regard to the discussion in *Wireless World* I cannot "go all the way" with any of those who have expressed views on the subject. My reasons for my present opinions, which are of course liable to modification with later experience, are as follows:—

(a) I have had considerable experience in broadcast listening, in common with most people in this country, but I have had no experience with wire broadcasting. I am, however, prepared to admit (for the sake of this argument only) that wire broadcasting can be perfectly free from interference and would in this sense be preferable to radio broadcasting on the present wavelengths. I am however, inclined to think that FM broadcasting would be very little different from wire broadcasting in this respect, and USW broadcasting may bring about similar results if the frequency be chosen at a sufficiently high value.

(b) The B.B.C. provides, in wartime, two alternative programmes, and I think it is true to say that, in many cases, there were three available B.B.C. programmes during peacetime. For

many people this is quite sufficient, but it is not sufficient for everybody, as is apparent from the fact that Luxembourg had a tremendous number of listeners before the war. Although I personally did not appreciate either the quality or the material of these transmissions, there is no doubt whatever that it was much appreciated by the majority of the people in this country. This must therefore be taken to prove either that the type of programme or the way in which it was "put over" appealed to a greater extent than do the B.B.C. programmes. On the other hand it may just have been the result of a desire to be able to change over to something different.

These remarks are intended to convey that the public requires more than two or three varied programmes, and I believe the wire broadcasting people state that they could produce six different programmes. If, however, six programmes were produced by one organisation, I do not think the public would be any more satisfied than they are at present; in other words, I believe that it is not so much the number of programmes as the variety of treatment which the public desires, and this variety of treatment is not likely to be provided by *any one organisation*.

(c) The great value of radio broadcasting over wire broadcasting is, of course, the fact that no site is inaccessible to radio broadcasting, but there are many houses in this country where wire broadcasting could be received only at considerable expense for the installation of the necessary service. The residents in these houses must not be denied the right to receive news and entertainment and, therefore, broadcasting must remain, apart from the necessity for providing programmes for English-speaking persons outside this country. This means that any wired broadcasting service must be *an additional service*.

(d) There is an extremely important political aspect of broadcasting. If it were possible for people in this country to receive only wired programmes, I should consider it absolutely essential that rival concerns should be permitted to provide alternative services. Since, however, we have wireless sets which are capable of receiving B.B.C. programmes, and which can also receive those of other countries, some of which are in the English language, this political difficulty does not arise. If, however, a single wire broadcasting system were to provide a substantial portion of the news and entertainment of this country it would, in my opinion, create the possibility of an extremely dangerous political situation.

Safeguards Needed

I have no doubt whatever about the honesty of the present Government or of its desire to tell the truth, but we are living in difficult times, when holders of strong opinions desire to enforce their will and their opinions on large numbers of their fellow citizens and even on those of other countries. It is thus supremely important that it should not be possible for any body of opinion, by control of the dissemination of news and information throughout the country, to impress its will upon large sections of the public.

For this reason alone, and quite apart from the fact that a number of programmes would not, in my opinion, satisfy the public if they came from one source, it appears to me that the existence of wire broadcasting alone in any section of the community, is quite unthinkable unless rival organisations have equal facilities for providing a service to every house. Furthermore, the broadcasting lines must be free from Government or other sequestration.

I have no objection to wire broadcasting so far as its effect on the public is concerned, except for the reasons given above, but it should be arranged that the

Wireless World Brains Trust—

broadcasting is done at radio frequency and a switch and aerial, together with the necessary frequency-selecting circuits must be provided so that the equipment may be used as a radio broadcast receiver when so desired.

(e) There is a further national and industrial reason which might render wire broadcasting a disadvantage. In this respect, I am not certain whether it is proposed that the wire broadcasting interests would provide their own receivers or whether they would be manufactured by a number of existing radio manufacturers, and that the public would be allowed to choose the particular receiver they wish to use. It is of the utmost importance that the public should be allowed to "pick its fancy."

To conclude, it appears to me that there are three possibilities for our post-war service:—

(1) To continue as at present, relying only upon the B.B.C. to provide our home entertainment. This is not entirely satisfactory, since it does not provide for separate programme - producing organisations. To achieve this we might:

(2a) Share the entertainment between the B.B.C. service and preferably two wire broadcasting organisations with a proviso that a single receiving instrument shall be used for both purposes and that the wire broadcasting interests shall provide a radio-frequency signal at the receiving end (as is done by the B.B.C.) but that the apparatus for converting it into sound shall be made by any manufacturer, and that the general public shall have a free choice as to the make of set they shall buy.

(2b) Share parts of the available B.B.C. programme time with other concerns whose duty it would be to provide programmes using B.B.C. studios and transmission systems. This would ensure different production methods and would introduce the variety for which the general public appears to hunger.

Finally, since wire broadcasting must be an additional service, there is no possibility of an economy in the receivers which might compensate for the increased cost of the broadcasting lines.

Wireless World

MORE VIEWS ON QUESTION No. 14. Why was the "odd" voltage of 132,000 adopted for the main transmission lines of the Grid System?

J. S. FORREST, of the Central Electricity Board, sums up on this question and also touches on the related one of the general "oddness" of supply voltages.

THIS question may most conveniently be considered in two parts (a) Why are high-tension voltages multiples of 11?, and (b) Why was the voltage of 132 kV adopted for the main Grid system?

(a) Last month C. R. Cosens made the interesting suggestion that the multiples of 11 arise from the fact that the voltage of the Daniell cell is roughly 1.1V. This may have had something to do with the use of 110V and 220V for the early DC supplies, but it is noteworthy that the pioneer and historic Deptford installation (1890) operated at 10,000V AC. In the case of high-voltage systems, there seems to be no doubt that the factor of 11 results from the practice of allowing for a 10 per cent. voltage drop in the transmission line. In fact, a document on Standard Voltages issued by the International Electrotechnical Commission (Publication No. 38-1938) specifies two series of voltages—"maximum voltages," multiples of 11, and "receiving-end voltages," multiples of 10. Similarly, British Standard Specification No. 77-1932 (now superseded), gives figures of 3,000, 10,000 and 30,000 for the "declared voltages," and 3,300, 11,000 and 33,000 for the corresponding "station voltages." It should be noted that the 10 per cent. voltage drop is an internal drop in the transmission system, and must not be confused with

the voltage variation at the consumer's terminals.

Many modern high-voltage systems, however, take the form of networks and interconnectors through which power may flow in either direction. The conception of "sending-end" and "receiving-end" voltages therefore no longer applies, and must be replaced by that of the "system voltage." It has happened that the former "sending-end" or "maximum voltages," i.e., the multiples of 11, have been generally adopted for the standard system voltages. Thus, at the present time, the most widely used system voltages are 11, 33, 66, 110, 132 and 220kV. Those interested will find the present standard system voltages in the revised British Standard Specification No. 77, published in 1939. This Specification also defines the standard AC distribution voltage as 230V (equivalent to 400V between lines).

(b) For any given power transmission system there is a most economical voltage which is determined by the transmission distance, the characteristics of the load, and the cost of plant (not only the line but also the terminal switchgear and transformers). The determination of the economic voltage is not a simple matter, largely owing to the fact that the characteristics of the load may be variable or not accurately known. For the present purpose, however, it may be sufficient to note that a voltage of the order of 1kV per mile is usually found to be satisfactory. Bearing in mind the transmission distances encountered in Great Britain it is seen that a voltage of 100-200kV would be required for the main Grid lines. Further, well-established power systems working at 33kV and 66kV were in operation in this country in pre-Grid days so that 132kV is seen to be a logical value for the main Grid voltage. There would have been no great technical difficulty in adopting a higher voltage, as 220kV lines were in service in the United States in 1923. Twelve years' operating experience, however, have confirmed the correctness of the original decision. Thus, the "odd" value of 132kV when considered against its proper background is seen to be almost the obvious choice!

Wireless World**Increase in Price**

It is regretted that rising costs of production compel our Publishers to increase the price of this journal from 1s. 3d. to 1s. 6d. The increase takes effect with the present issue.

SUNSPOTS: Close of the Present Cycle

DR. SETH B. NICHOLSON, of the Mount Wilson Observatory, recently announced that a sunspot group has been observed in the relatively high solar latitude of 32 deg. North. This may have been the first sunspot belonging to a new cycle of solar activity, and its appearance is therefore, evidence that the present cycle is coming to an end. This event was, in fact, expected to occur about 1944.

The cycles of solar activity are of significance in radio in that the amount of ionisation produced by the sun in the upper atmosphere varies in phase with them. Thus the critical frequency of the ionosphere layers is much higher at sunspot maximum than at the minimum, and consequently higher working frequencies must be used for short-wave transmission at the former period than at the latter.

The present solar cycle commenced in 1933, and its progress—in terms of the annual means of the sunspot relative numbers—is shown in the graph of Fig. 1. An inspection of this would seem to indicate that the cycle would come to an end about 1944, but precision on this point is by no means easy, since the cycles vary considerably in length.

Besides varying in size, and in the frequency of their appearance

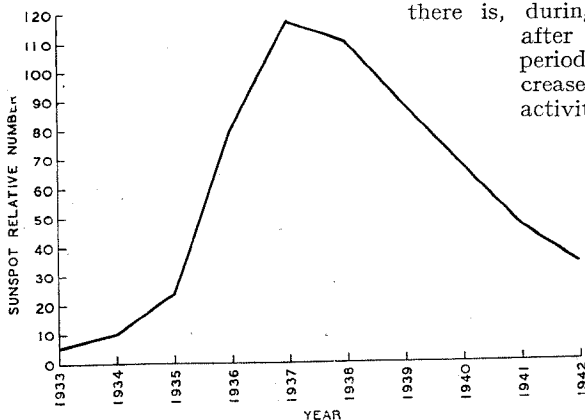

—which is what is indicated in Fig. 1—the sunspots also change their latitude as the cycle progresses. At the beginning of a cycle they occur on the solar surface in two belts which are situ-

ated in about 30 deg. North and South latitude. As the cycle progresses these belts gradually drift towards the solar equator, and, towards the end of the cycle, they are situated in about 8 deg. North and South latitude. But, some time before the sunspots finally cease to appear in these regions, a fresh phase of activity gives rise to sunspots which appear in the high latitudes again, and then a new cycle commences. So that, at the minimum of the cycle, there are four belts in which the sunspots occur, two in high and two in low latitudes, on either side of the solar equator. The appearance of a sunspot in a high latitude is, therefore, a sign that the current cycle is coming to an end. Fig. 2 is a graph on the shift in the mean latitude of the sunspots during the cycle which began in 1913 and came to an end in 1923, and serves to illustrate this point. The solar activity increased rapidly from 1924 onwards.

The New Cycle

It is not a necessary implication, however, that, as soon as the minimum is passed, there will be a great decrease in solar activity and a consequent big increase in the working frequencies for short-wave transmission. Although this does occur sometimes, an examination of former sunspot cycles shows that, more often than not, there is, during the first year after the minimum period, very little increase in the solar activity. It is during the second year of the new cycle that the big increases most often occur.

Fig. 1. Annual means of sunspot numbers during the present solar cycle.

There is one other interesting change in sunspot phenomena which takes place at the end of a cycle. The sunspots most often appear in pairs, the one which lies in the forward position with

regard to the direction of the sun's rotation being known as the "leader" spot, and its companion as the "follower." These sunspots have opposite magnetic polarity, and during any one cycle

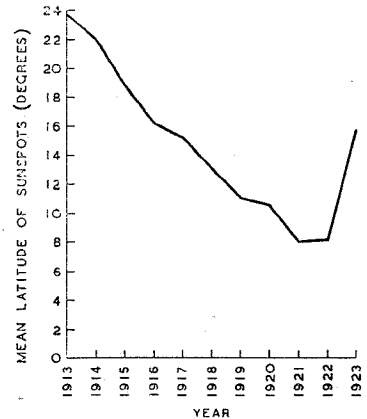

Fig. 2. Shift in mean latitude of sunspots during the solar cycle 1913-1923.

the relative polarity of the leader is, for example, always of North magnetic polarity, and the follower always of South polarity. At the end of a cycle this polarity is reversed, so that the leader and follower sunspots of the new cycles are reversed in magnetic polarity compared with those of the old cycle. In the case of the group observed at Mount Wilson the leader spot was so little in advance of the follower that it was hard to say whether it had a different polarity to the leader spots of the present cycle or not.

T. W. B.

"DESIGN OF SIMPLE OHMMETERS"

THE mathematical expression (15) on page 269 of the previous issue was incomplete. It should have been an equation reading $R = R_{36} /$ (divided by the expression given).

GOODS FOR EXPORT

The fact that goods made of raw materials in short supply owing to war conditions are advertised in this journal should not be taken as an indication that they are necessarily available for export.

RADIO DATA CHARTS — 11

Frequency and Wavelength

By

J. MCG. SOWERBY,

B.A., Grad.I.E.E.

(By permission of the Ministry of Supply)

THERE has been some discussion in recent months concerning the most desirable nomenclature for frequency and wavebands; but before coming to this, let us get one or two fundamental ideas straight. The very simple equation connecting frequency and wavelength is

$$\text{Frequency} \times \text{Wavelength}$$

$$= \text{Velocity of propagation.}$$

The frequency (f) of the wave is the number of complete alternations per second, and since the wave is travelling with velocity (v), f alternations will pass a given point in one second. In the same time one wave will have travelled a distance numerically equal to v , and so f waves will occupy this same distance. From this the length (λ) of one wave may be found by dividing v by f , and the equation above is simply a more convenient way of writing the same thing.

It will be realised at once that the fundamental quantity in the equation is the frequency. The wavelength is, so to speak, merely a by-product of the velocity, which in turn depends on the medium in which the wave is being propagated. For example, suppose we have an oscillator working at a fixed frequency and this is coupled to an aerial. Then the wavelength of the alternations in space may be found from the equation by putting 300,000,000 metres per sec. for the velocity. This is the velocity of propagation of wireless waves in free space and is equal to the velocity of light; this is hardly surprising since the only material difference between a beam of wireless waves and a beam of light is the frequency—that of light being enormously the higher.

We have now a wavelength associated with our fixed frequency oscillator, but this is not unique. To see the truth of this we may couple our oscillator to a transmission line loaded by inductances (such lines are used in telegraphic work). Under these conditions the velocity of propagation may fall to a tenth of its previous value (i.e. to 30,000,000 metres/sec.) and the wavelength

on the line will be correspondingly shortened. Now we have *two* different wavelengths associated with our oscillator, and of course there can be innumerable others in between. Thus, academically we should always think in terms of frequency, since it is fixed, and never in terms of wavelength, which is variable.

However, things are not quite as bad as this, for it is fortunate that in most radio work the velocity of propagation differs from the velocity of light by only a very small percentage, so for practical purposes we may regard this as our standard velocity and compute all wavelengths on this assumption.

In the early days of wireless it was the custom to use wavelengths almost exclusively; later there was a tendency to use frequency—modern communication sets are calibrated in terms of frequency, for example. Nowadays, measurements at frequencies of the order of 100 to 1000 Mc/s are carried out with transmission line sections, lecher wire systems, or other methods where a length is measured; so it is natural to think in terms of wavelength. At higher frequencies still cavity resonators are used, and here it becomes natural to think in terms of frequency again as the system is analogous to the Helmholtz resonator. Hence there will be points in the radio spectrum where it will be convenient to think in terms of frequency and others where wavelength will

be the better viewpoint. The moral is for the radio engineer to have equal facility in the use of either. This is, perhaps, a counsel of perfection, but it is hoped that this chart may be of some help.

As mentioned above there has recently been some discussion as to the best method of dividing the radio spectrum into various bands. We cannot repeat here all the arguments for and against the various schemes, but in the author's opinion the best yet put forward appeared in *Wireless World* (Feb. 1943, p. 51). A table which was published there is repeated here with some minor modifications.

The chart is based on the equation

$$f \text{ (kc/s)} \times \lambda \text{ (metres)} = 300,000.$$

and it is labelled to correspond with the table. Band 1 is omitted from the chart as the wavelength at these frequencies is seldom required, being of the order of miles. Band 7 is at present of interest only to a very few and so is also omitted. Bands 2 to 5 inclusive appear on the chart which, it should be noted, is not a proper abac at all in so far as no ruler or straight-edge is required for its use. It is only necessary to find by inspection the appropriate band on which the required frequency (or wavelength) appears, when the corresponding wavelength (or frequency) can be read opposite it on the adjacent scale.

Example

What is the wavelength corresponding to 400 kc/s (0.4 Mc/s)? Find the right band by inspection—in this case band 3. Opposite 400 kc/s on the frequency scale appears 750 metres on the wavelength scale. This is the required figure.

Band	Frequency	Frequency Name	λ in Metres	Waveband Name
1	Below 30 kc/s	Very low	Above 10^4	Myriametre
2	30–300 kc/s	Low	10^4 – 10^3	Kilometre
3	300 kc/s–3 Mc/s	Medium	10^3 – 10^2	Hectometre
4	3–30 Mc/s	Medium high	10^2 –10	Decametre
5	30–300 Mc/s	High	10–1	Metre
6	300–3000 Mc/s	Very high	1–0.1	Decimetre
7	3000–30,000 Mc/s	Ultra high	0.1–0.01	Centimetre

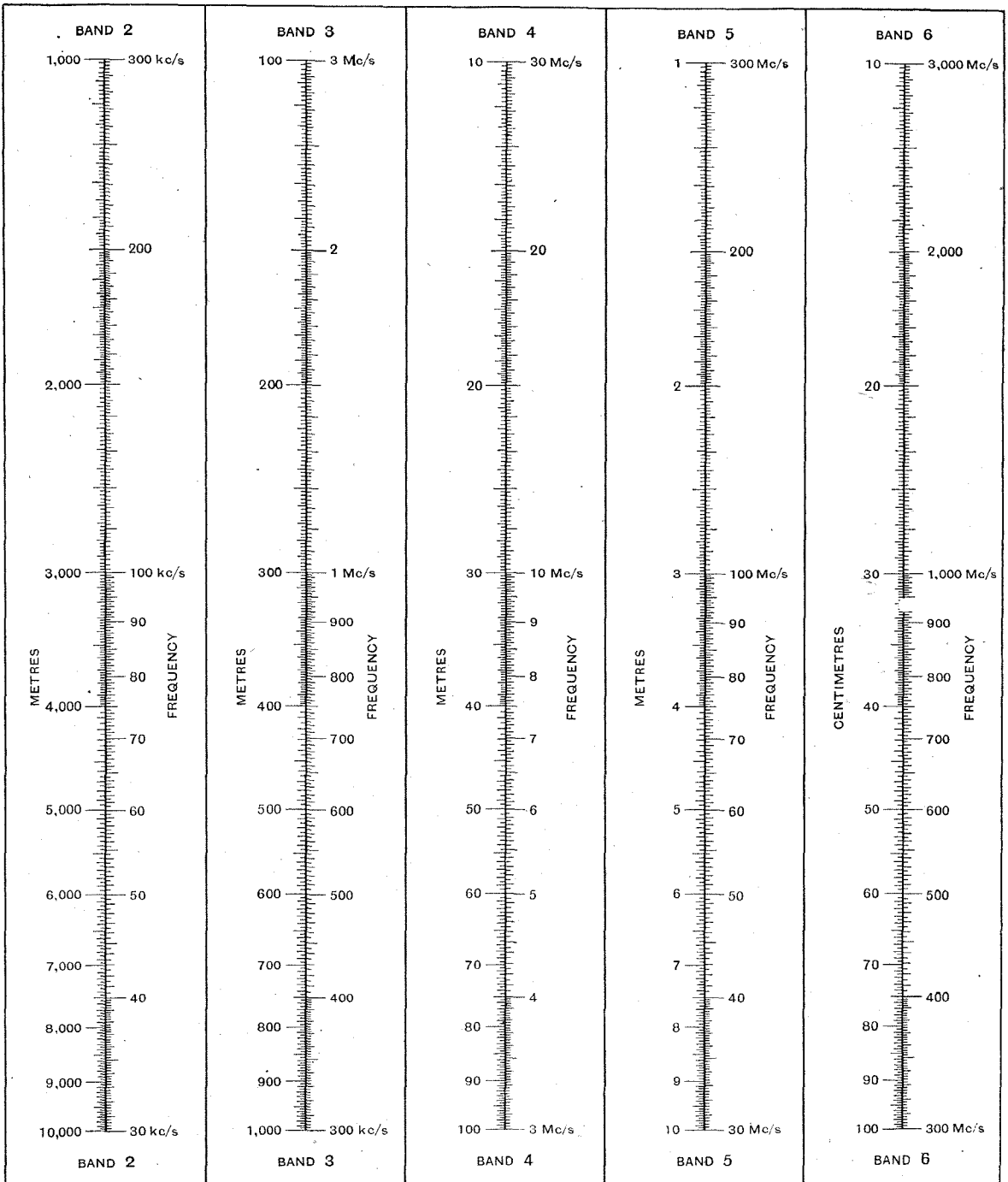

RADIO FREQUENCY AND WAVELENGTH

Wireless World
COPYRIGHT

USE OF VALVES

Safety Precautions to Prevent Overrunning

GRID emission of a thermionic nature was considered in the preceding section of this article. It is necessary to consider a further effect which may occur when a valve is used under conditions where grid positive current is flowing. For example, grid positive current will flow to the control grid of a valve operating under "positive drive Class B" conditions or, momentarily due to overload, in the case of a valve which is nominally working under Class A conditions. The flow of electrons to the grid in such cases as have been mentioned may result in electrons being released by impact from the grid material. This form of grid emission, arising from electron bombardment, is known as grid secondary emission and will result in the grid losing electrons, probably to the anode. Thus the flow of electrons from the grid, by secondary emission, offsets the arrival of electrons to the grid from the cathode. This phenomenon is illustrated in Fig. 1.

Starting at a point in the neighbourhood of $V_g=0$, the grid current is zero. If the grid is made more positive, electrons are attracted to it, thus constituting a grid positive current. This current rises to a maximum at a point shown on the diagram where $V_g=A$, and subsequently it begins to fall because of the increasing loss of electrons from the grid arising from the resultant grid secondary emission. As the positive grid voltage is still further increased and the bombardment of the grid becomes greater, the secondary emission increases and the grid negative current will eventually attain the same numerical value as the grid positive current which is causing it. At this point, $V_g=B$, the total external grid current is zero. Beyond this point the value of the grid negative current becomes numerically greater than the grid positive current, and thus the resultant grid current is negative. At a still higher value of positive grid voltage, a further effect becomes apparent when the

By J. R. HUGHES, A.M.I.E.E.
(British Radio Valve Manufacturers' Ass'n)
(Concluded from page 259 of previous issue)

potential gradient around the grid is such that the secondary electrons move back to the grid itself rather than to the anode. This, of course, results in a drop of the grid negative current and at the point $V_g=C$ the total external grid current once more becomes zero. From here on, the grid current is increasingly positive.

It will be apparent from the above that there are three sets of conditions under which the external grid current can be zero and that the corresponding grid voltage can be either $V_g \sim 0$, $V_g=B$ or $V_g=C$.

If the grid of a valve has no DC connection to the cathode the external grid current is evidently zero. It may be, however, that the valve is operating at the point C on its grid characteristic and that the grid, consequently, is at a large positive potential. Under these conditions a considerable electron current will be flowing to the grid and an equally considerable electron current flowing from the grid as a result of secondary emission. The condition is a stable one and the valve may remain in this state indefinitely. Obviously, since the grid potential is large and positive, the anode current of the valve will be considerably higher than the normal and the effect of this will be to increase the anode dissipation and thus damage the valve.

This is one very important reason for the insistence in the Code of Practice that "... in no circumstances should valves be operated without a DC connection between each electrode and the cathode."

Mention is also made in BS. 1106 of the practice of "keying" by opening the screen circuit of a valve whilst the normal anode and grid voltages are maintained. This is another example of the operation of a valve without a DC connection between each electrode and the cathode.

The phenomenon of grid secondary emission, moreover, is of importance even if the grid has a DC connection to the cathode. Referring again to Fig. 1, it will be seen that two dotted lines are included, marked R_1 and R_2 . These are simply the current/voltage characteristics for two values of resistance, drawn on the same co-ordinates as the grid current curve. The flow of grid negative current in a valve circuit where a DC connection exists between the grid and the cathode gives rise to a voltage drop down the DC resistance of such polarity that the grid becomes positive with respect to the cathode. R_1 and R_2 are assumed to be two values of external grid resistance where, of course, R_1 is greater than R_2 .

Considering first the operation of the valve with an external grid connection having a resistance R_1 , it will be observed that the grid current curve and the R_1 characteristic intersect at the two points D and E. These two intersections are conditions of equilibrium which, once established, may be maintained without the application of any external EMF to the grid. At D the equilibrium is unstable, but if a positive potential having a value greater than E is applied to the valve grid and then removed, the grid voltage falls towards zero until the stable point of equilibrium E is reached. Thus a momentary application to the valve grid of a positive potential greater than E (as, for example, by a condition of overload) may result in the phenomenon known as "grid-locking."

On the other hand grid locking is impossible in the case of the same valve operating with the smaller value of external grid resistance R_2 because that dotted line nowhere intersects the grid current characteristic.

This argument further emphasises the requirement that the DC connection between each electrode and the cathode should have the minimum practicable resistance. The Code of Practice in fact states "... the apparent advantage of an 'open-circuited' elec-

trode, or of a high resistance path, may be defeated by the valve's secondary emission characteristics."

Grid Rectification Biasing.—

The very common use of grid rectification to obtain a bias voltage, particularly in cases of valves used as oscillators or RF power amplifiers, is the subject of another precaution covered by BS.1106. This type of circuit is no doubt well known and consists of a condenser and resistance used in conjunction with a valve which is being driven into grid positive current on part of each cycle. This grid positive current produces an accumulation of electrons in the grid condenser and the mean charge potential is adjusted to the desired value by an appropriate choice of condenser capacity and grid-leak resistance.

In the event that the valve drive is cut off for any reason, the flow of electrons to the condenser every cycle will cease whilst the leakage of electrons through the grid-leak resistance will continue until, finally, the potential across the condenser will fall to zero. As the biasing potential drops the anode current will rise and may very greatly exceed the rated anode current. To avoid the damage to the valve which can arise in these circumstances the Code of Practice recommends that grid rectification biasing should never be used alone. It mentions one of the possible methods of avoiding the risk described, by recommending that some of the desired bias potential should be secured in the normal manner by a resistance in the cathode lead. Thus if the grid rectification bias fails the increasing anode current will produce an increasing cathode bias and thus can save the valve from damage. For any particular application it is very desirable that the valve manufacturer's advice should be taken as to the minimum cathode bias which will ensure a reasonable security against damage.

Miscellaneous.—It will be of interest to consider briefly two lesser known miscellaneous points which are covered by the Code of Practice.

The first reads: "It is, in general, undesirable that valves should be operated in such circuit conditions that the cathode cur-

rent is normally cut off." This practice, which is often adopted in equipments which are required intermittently but at short notice, may be permissible with some valves but it should not be adopted without first taking the advice of the valve manufacturer. When a valve is operated in a normal manner the cathode emission carries with it minute quantities of impurities in the cathode coating. These impuri-

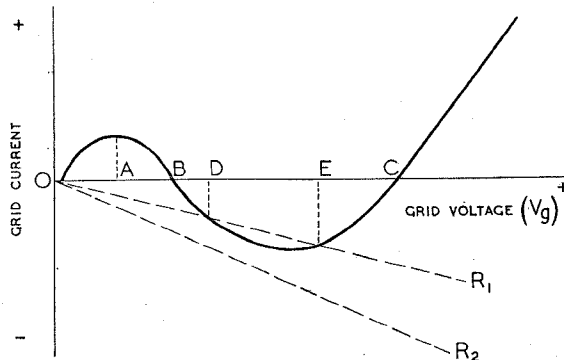

Fig. 1. Current/voltage characteristic of a grid in a valve containing another electrode at a positive potential.

ties are deposited elsewhere in the valve and have only a negligible effect upon the useful life. On the other hand, if the cathode is maintained at operating temperature but the cathode current is cut off as, for example, by cutting off the anode voltage, these minute quantities of impurities fall back on to the cathode itself with the result that the cathode surface is slowly "poisoned" and its emissivity decreased.

A further cause of cathode "poisoning" may arise from the presence in the bulb of very small quantities of residual gas. Under the operating conditions the residual gas is ionised by collision as has already been discussed, whereas this will not be the case if the cathode current is cut off. It can be shown that un-ionised residual gas is less rapidly reabsorbed than when ionised and accordingly, in the absence of space current, residual gas may remain and result in cathode "poisoning."

The second of the two miscellaneous points referred to is concerned with contact potential.

The contact potential between any two electrodes in a valve is defined very simply in the Code of Practice as the "voltage corresponding to start of positive current to any electrode." Evidently, the assessment of the voltage at which a current starts to

flow between two electrodes is dependent upon the sensitivity of the method used to detect the current and it is therefore usual in practice to define the contact potential as the potential at which the positive current reaches some small arbitrary value. The value of the contact potential is dependent upon the two surfaces under consideration and any variation in either of the surfaces will produce a change of contact potential.

The question of contact potential is of importance in a number of cases, but particular mention might be made of the case of the cathode/grid potential in high-gain triodes. With these valves, where the contact potential may easily be of the same order as the bias voltage, it is obviously important that due regard should be paid to it.

The Code of Practice emphasises that "circuits which are critical as regards control of contact potential should be avoided . . ." This condition must be observed because, as has been stated, the contact potential is dependent in any given case upon the electrode surfaces. Contact potential therefore changes with temperature and throughout the life of the valve and cannot be regarded as a stable or constant quantity.

Mercury Vapour Rectifiers.—A far smaller number of valve users is concerned with mercury vapour rectifiers than with "hard" valves of one sort or another. Partly because of this but partly because each mercury vapour application tends to be regarded as an individual engineering problem in itself, mercury vapour rectifiers are not taken quite so much for granted as are "hard" valves. Nevertheless BS.1106 does include a short section dealing with this subject.

Use of Valves—

The essential difference between a vacuum rectifier and a mercury vapour rectifier is that the latter contains a certain amount of mercury, partly in liquid form and partly vapour, depending upon the temperature conditions. When a potential difference is applied between the anode and the heated cathode an electron stream flows in the normal manner; and in their passage from the cathode to the anode electrons will collide with mercury vapour molecules and produce a state of ionisation. The positive ions on account of their high mass and the low potential gradient move towards the cathode at a relatively low velocity, and will neutralise the space charge existing between the cathode and the anode.

In a vacuum valve the presence of the space charge has the effect of reducing the space current and of necessitating the use of relatively high anode potentials. To remove the space charge entirely in a vacuum rectifier would require the application of very high anode voltages which might damage the valve by excessive anode dissipation and liberation of gas. The cathode, moreover, would be rapidly destroyed by the bombardment of positive ions which would be travelling at an extremely high velocity on account of the large potential between the anode and the cathode.

The introduction of mercury vapour into the valve and the consequent neutralisation of the space charge without the need for very great anode potentials, permits the anode current of the mercury vapour valve to approach the total emission of the cathode, whilst avoiding the risk of cathode damage from high-velocity bombardment.

The potential difference which is necessary between the anode and the cathode in a mercury vapour rectifier in order to produce a satisfactory ionisation of the vapour is usually less than 20V. Thus, provided the anode voltage is of that order, the anode current will be unrestricted by the presence of a space charge and will only be limited by the emission available from the cathode. The principal property of the mercury vapour rectifier therefore is that it will pass a relatively large current with only a very

small potential difference across it. The very low value of the rectifier's resistance and its practically constant voltage drop require the use in practice of a limiting resistance in series with the rectifier.

If it should happen that the anode voltage were applied to the rectifier, before an adequate amount of mercury had been

cathode is heated before the application of the anode voltage. Mercury vapour rectifier cathodes are normally of the high current low voltage type having a considerable thermal capacity, and an appreciable time is required for the cathode to reach its operating temperature. Subsequent to this the heated cathode will cause the evaporation of a certain amount of mercury until a new state of equilibrium exists inside the bulb. If the valve has not been recently used, or if it has been disturbed so that the mercury may have splashed on to the emissive coating of the cathode, it will be necessary to take still greater care that an adequate preheating time is allowed. In the latter event, for instance, the presence of liquid mercury actually on the cathode will result in very rapid evaporation and an excessive mercury vapour pressure around the cathode. If the anode voltage were applied whilst this condition persisted, arcing would take place between the electrodes and the valve would be damaged. In these exceptional cases it will generally be found that the manufacturer recommends the preheating time of between 15 and 30 minutes but for the routine starting of valves in regular use, the preheating time is less than this and may even be as short as a minute. In either case the length of the preheating time depends upon the size of the valve and upon the room temperature and it is safest to make sure that the recommended times for any particular type are known.

It is a common practice, and a very good practice, to make use of automatic time delay switches to take care of the necessity for a preheating time. These switches are generally thermal in principle and their release time, which is obviously determined by the rate of cooling of the bi-metal element, is far from negligible. It can happen, therefore, that the rectifier might be switched on again, soon after switching it off, before the delay switch has had time to return to the unoperated condition. If this should happen it is obvious that the anode voltage and the filament voltage will be applied to the rectifier simultaneously. The chance of this occurring is, no doubt, small, but it is a point well worth remembering.

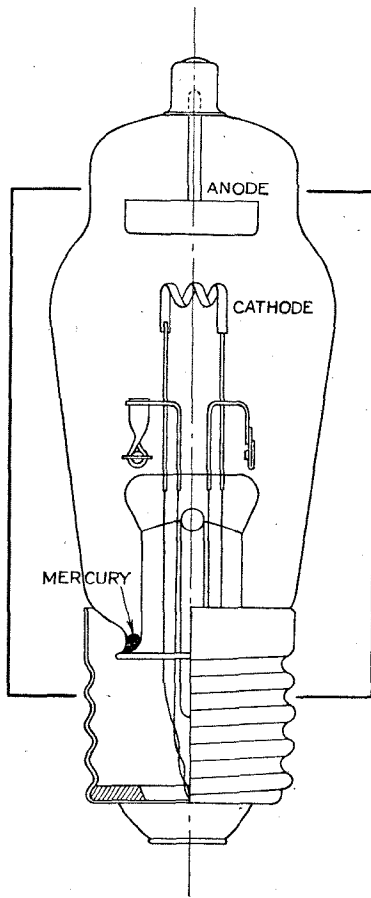

A typical mercury vapour rectifier.

vaporised, the flow of electrons from the cathode to the anode would result in an insufficient number of positive ions to neutralise the space charge. The internal resistance would be excessively high and the voltage drop across the rectifier would accordingly be high also. Under these conditions, the velocity of such positive ions as did exist would be sufficient to cause cathode damage by bombardment, and partly for this reason a preheating time is always specified in the case of mercury vapour rectifier.

By preheating time is meant the period during which the

The factor of temperature is always of considerable importance in the operation of mercury vapour rectifiers. The degree of ionisation of the mercury is dependent upon the pressure, and hence upon the temperature of the gas, as is also the rate of de-ionisation. If in any mercury vapour rectifier the temperature of the condensed mercury is too low, vaporisation and subsequent ionisation will be insufficient to bring about the desired condition of low voltage drop across the valve. If, on the other hand, the temperature is too high, then de-ionisation will be retarded. It will be remembered that the process of ionisation is effected by the flow of electrons from the cathode to the anode on each half-cycle when the anode is positive with respect to the cathode, and it is, therefore, evident that ionisation is required to take place in a time short compared with the length of one half-cycle. Similarly, the vapour must de-ionise at the beginning of each succeeding half-cycle rapidly enough to ensure that de-ionisation is sufficiently complete to enable the rectifier to withstand the peak inverse voltage. If the process of de-ionisation is retarded, the internal resistance of the rectifier will be too low to withstand the peak inverse voltage and breakdown and destruction of the cathode surface will result. It is, therefore, necessary to control the operating temperatures of mercury vapour rectifiers and with large valves of this class, when normal ambient temperatures are likely to vary unduly, some form of forced air temperature control must be employed.

The published data covering mercury vapour rectifiers always specifies a limiting range of condensed mercury temperature, and due attention must be paid to this if reliable service is to be expected from the valve.

The very high current-carrying capacity of mercury vapour rectifiers, as compared with vacuum rectifiers, gives rise to the need for a special precaution in the case of the larger directly heated types. With these it may well happen that the anode current is of the same order as the filament-heating current. Moreover, as has already been stated, the voltage drop across the rectifier is so low that it

may be of the same order as the filament-heating voltage. If the anode and filament voltages are connected in phase or 180 deg. out of phase, as would be the case in a normal bi-phase half-wave circuit, maximum current to the anode will coincide on each half-cycle with peak positive voltage at one or other end of the filament. This will tend to draw more emission from one end of the filament than from the other, and will also result in unequal amplitude of current in the two halves of the filament. For this reason the Code of Practice lays down that with large directly heated mercury vapour rectifiers, the anode voltage and the filament voltage should be arranged to be substantially 90 deg. out of phase. If this is inconvenient, steps may be taken to reverse the filament terminals at regular intervals, but if this is not possible, the rectifier will usually have to be operated with reduced ratings.

"INTRODUCTION TO VALVES"

THIS popular book, of which a second edition has just been issued, was originally written for those who, with little or no previous experience, are called upon to handle valves, CR tubes and allied devices. Though the introductory chapters cover valve theory, it deals largely with practical circuit applications of valves.

A new chapter describing specialised valves, such as those for very high frequencies, including the magnetron, has now been added. Electron multipliers, "magic eye" tuning indicators and cold cathode rectifiers are also dealt with. Minor revisions have also been made.

"Introduction to Valves" is by F. E. Henderson, A.M.I.E.E., of the G.E.C., and is issued by our publishers at 5s. (by post, 5s. 3d.).

ELECTRICAL INDUSTRIES RED CROSS FUND

THE total of covenanted subscriptions and donations to this Fund now amounts to over £17,000. Among the names of firms with wireless interests which appear in the latest lists issued are Ferranti, Ltd. (£200), and Kolster-Brandes, Ltd. (£100). The sums given represent covenanted annual subscriptions for seven years or for the duration of war.

Information can be obtained from the Joint Secretaries of the Fund, c/o The E.D.A., 2, Savoy Hill, London, W.C.2. Contributions should be sent direct to the Electrical Industries' Red Cross Fund, St. James's Palace, London, S.W.1.

GALPINS

ELECTRICAL STORES

"FAIRVIEW,"

LONDON ROAD, WROTHAM,
KENT.

TERMS: Cash with Order. No C.O.D.

Regret Orders from Eire and Northern Ireland cannot be accepted.

DYNAMO by Crompton, output 50/75 volt 25 amp. D.C., speed 1,750, four-pole, shunt wound, large ring oiler bearings, complete with pulley, ready for immediate use. Price **£10** carriage paid.

SUPER SENSITIVE RELAYS, multi leaf, P.O. type, very low M/A working, as new. Price **15/-** each, post free.

PRE SELECTOR SWITCH, complete with very sensitive relay, 3-arm rotary, 48 contacts, as new. **30/-** each, post free.

D.C. MOTOR, shunt wound, condition as new, high grade, ball bearing, $\frac{1}{2}$ h.p., 110 volts. Price **40/-**, carriage paid.

AUTO-TRANSFORMER, 2,000 watts, tapped 0-110-200-220-240 volts, as new. Price **£8.10.0**, carriage paid.

VOLTMETERS, $2\frac{1}{2}$ in. dia., panel mounting moving coil, modern type, by famous maker 10 v. range, F.S.D. 5 m.a. Price **32/6**, post free.

AMPMETERS, description as above. Ranges 0- $\frac{1}{2}$ and 0-20 amps., F.S.D. 15 m.a. State which reading required. Price **25/-** each, post free.

DUBILIER RESISTORS, new lead and wire ends, 2 watt, 30,000 ohm, $\frac{1}{6}$ each or 15/- per doz., post free. Ditto, 1 watt, 5,000 ohm., $\frac{8}{6}$ per doz., post free.

RESISTANCE MATS, size 8in. by 6in., set of four. 80, 80, 150 and 690 ohms, carry $\frac{1}{2}$ to $\frac{3}{4}$ amp. Price, set of four, **5/-**, post free.

MOVING COIL MOVEMENTS, needing slight repair, modern type, famous makers, deflection 10 m.a. Price **15/-**, post free.

RIGHT ANGLE DRIVE, mounted in gunmetal box, all ball bearing, $\frac{3}{8}$ in. dia. shafts, as new. **12/-** each, carriage paid.

RECORDING AMPMETER, in ironclad case, meter movement wants repair, no pen, clock perfect, range 0-3 amps. Price **£7**, carr. paid.

MOTOR-DRIVEN PUMP, for oil or water, motor 220v. D.C., 1 amp., 1,250 r.p.m., maker Keith Blackman. Price **£6 10s.**, carr. paid.

200 AMP. KNIFE SWITCHES, S.P., D.T., in first-class condition. **15/-** each.

200 AMP. CABLE, V.I.R., as new, rubber cover perfect, size 37/13, lengths 30 to 40 yds. Price in lengths, **5/-** per yard, carr. paid.

DYNAMO, maker C.A.V., output 20 volts, 10 amps, speed 1,500 r.p.m., ball bearing. Price **£5**.

ROTARY CONVERTOR, D.C. to D.C., input 11 volts, output 1,100 volts, 80 watts, will operate successfully on 6 volt input. Price **50/-**.

MASSIVE GUNMETAL WING, complete with long handle, for use with $\frac{3}{8}$ in. dia. wire cable weight 50 lbs., condition as new. Price **£3** carriage paid.

ELECTRIC LIGHT CHECK METERS, well-known makers, first-class condition, electrically guaranteed, for A.C. mains, 200/250 volts 50 cy. 1 phase 5 amp. load, **10/-** each; 10 amp. load, **12/6**, carriage 1/-.

WATT WIRE END RESISTANCES, new and unused, assorted sizes (our assortment). **6/-** per doz., post free.

SOLID BRASS LAMPS (wing type), one hole mounting, fitted double contact, S.B.C. holder, and 12 volt 16 watt bulb. Price **3/6** each, post free, or **30/-** per doz., carriage paid.

TUNGSTEN CONTACTS, $\frac{3}{8}$ in. dia., a pair mounted on spring blades, also two high quality pure silver contacts, $\frac{3}{8}$ in. dia., also on spring blades, fit for heavy duty, new and unused. There is enough base to remove for other work. Price, the set of four contacts, **5/-**, post free.

Do You Know?

IN pre-war days to be a regular reader of *Wireless World* always tended to set a man somewhat apart from his fellows as being one possessed of superior knowledge and intelligence, and this was true even of the man who bought it solely for the purpose of wrapping up his fish and chips; it at least showed that he appreciated the fact that the good quality of the paper on which it was printed rendered it more greaseproof than lesser journals. In fact, it is true even to-day, as a "Waaf" of my acquaintance tells me that she always carries a copy because it creates a good impression among those in authority, thereby opening the gateway to certain privileges denied to the less wise virgins in her unit.

However, *Wireless World* readers, like other great men of science, appear to be somewhat shaky where the more elementary facts of their chosen subject are concerned, judging by a recent experiment which I carried out in London. It is, I think, betraying no secrets to the enemy when I say that the attention-compelling cover of this journal is to be seen everywhere



"A Waaf of my acquaintance"

nowadays in tubes, buses and other public places, being pored over by studious young men in uniform muttering angry disagreement to themselves as they peruse its pages. I have, for some weeks past, made it my business to get into conversation with them by using my own copy of the journal as a medium of introduction and have been truly astonished at the amount of ignorance they have displayed concerning the veriest elements of radio and electrical science, whilst at the same time being on terms of the greatest familiarity with abstruse aspects of it, which would be not unworthy of my own attention.

By

FREE GRID

My stock question to them has been the seemingly simple and elementary one: "What is the speed of electricity?" In the most part I have received the instantaneous and unthinking reply: "186,000 miles-per-second," and have had quite a task explaining that I am not seeking their opinion on the speed of ether waves but of the humble electron moving round a simple DC circuit like that of an electric torch.

I am wondering if I was singularly unfortunate in my choice of questionees (Government-sponsored word) or whether the majority of you are equally ignorant. Please let me know on a postcard. The Editor's decision will be final, even if he doesn't know the proper answer himself.

"All for Adolf"

I AM particularly glad to see that the Editor is taking a firm line on the question of wire or wireless broadcasting, since it is a course which I have been urging on him for a long time. It is quite evident, however, that neither he nor his Brains Trustees are as well informed as myself regarding the true extent of the underground preparations that are being made to deprive us of our ethereal freedom.

I can scarcely believe that such normally well-informed people as those whose views on the subject have been published in the *Wireless World* Brains Trust—D. A. Bell in particular—can be unacquainted with the latest developments in "conducted carrier" technique as their remarks would lead me to believe, and I can only assume that the grim jest contained in the use by the "All-Metal" protagonists of the expressions "piped transmissions" must have escaped their notice.

The truth of the matter is, of course, that the programmes are to be distributed to us along the gas mains—surely a very appropriate medium for them—for the very simple reason that in our larger cities with their huge preponderance of gaunt pre-war houses, mostly occupied by the less fortunate sec-

tion of the community, gas is still the only illuminant available—and this in spite of the much-vaunted "grid."

With modern "conducted-carrier" high-frequency technique the absence of ordinary electrical insulators is no disadvantage as very little energy will be dispersed in the surrounding soil. Actually, gas pipes possess the very great ad-



"Prelude to piped programmes."

vantage that there is no noisy and troublesome AC or DC to filter out. Naturally a certain amount of interference will travel along the pipe, but it can easily be "choked off" by winding the mains in the form of an inductance at the point where it enters the house, an arrangement which I myself first brought to notice in these pages in the case of water pipes as long ago as September 18th, 1934. The original sketch is reproduced herewith.

There does, of course, remain the problem of the dwellers in our ancient villages who still pig-headedly prefer the tangible light of oil lamps to the "flowing" promises of the Central Electricity Board. This is, however, to be solved by the use of helicopters (now being developed at the taxpayers' expense for alleged war purposes) to hover over the villages and distribute broadcasting communally by giant loud speakers. The programmes will be beamed to the helicopters direct from London. In this manner it is hoped to get the inhabitants of each village to club together and pay for mains to be laid on to their locality in order to stop the infernal racket overhead, thus saving the lighting and heating authorities a lot of expense.

Personally speaking, Adolf's "New Order" seems to me by far the lesser evil of the two, and I am seriously thinking of rousing the masses to support him with the stirring slogan of "All for Adolf." After all, even a Volksempfänger is preferable to no wireless at all.

WORLD OF WIRELESS

B.B.C. DIRECTORS

FOLLOWING the resignation through ill-health of Sir Cecil Graves, Joint Director-General of the B.B.C., the Board of Governors have appointed the remaining Joint Director-General, Robert Foot, as sole Director-General and executive officer of the Corporation.



Sir Noel Ashbridge.

The Governors have also made a new appointment, that of Editor-in-Chief, and have chosen W. J. Haley, who, with the D.G., will be jointly responsible for the character and quality of the Corporation's output. Mr. Haley, who served as a wireless operator at sea during the latter part of the Great War, is joint managing director of the Manchester Guardian and Evening News, Ltd., and a director of Reuters and of the Press Association.

General approbation will be felt in wireless circles by the appointment of a technician to the important post of Deputy Director-General. Sir Noel Ashbridge, who has been appointed to this office, joined the B.B.C. in 1926 as Assistant Chief Engineer, becoming Chief Engineer in September, 1929. For six years prior to joining the B.B.C. he was with Marconi's at the experimental station at Writtle, Chelmsford. He is a member of the Radio Research Board and Past-President of the I.E.E.

Sir Noel's successor as Controller of the Engineering Division is H. Bishop, at present Assistant Controller. He came to the B.B.C. from the Marconi Company just after the first Chief Engineer, P. P. Eckersley, early in 1923. Previously he had worked on the original 2LO

transmitter at Marconi House, London. In 1929 he was appointed Assistant Chief Engineer.

R. T. B. Wynn, who has been appointed Assistant Controller, Engineering Division, also came to the B.B.C. from the Marconi Company in 1926 as head of the Technical Correspondence Department, becoming Senior Superintendent (Engineering) in 1935.

I.E.E. PRESIDENT

THE first meeting of the 1943-44 Session of the Institution of Electrical Engineers will be held on Thursday, October 7th, at 5.30, when Col. Sir A. Stanley Angwin, who takes up his appointment as President on September 30th, gives his inaugural address.

Sir Stanley, who was created a Knight-Bachelor in June, 1941, has been Post Office Engineer-in-Chief for the past four years, having previously been Deputy Engineer-in-Chief. He joined the Post Office in 1906 and has contributed largely to the design of the Post Office transmitting stations and the introduction of the co-axial cable for the television service.

Sir Stanley has represented the Post Office at many international telecommunications conferences and is a member of the Television Advisory Committee.

AUSTRALIAN RADIO

SIR ERNEST FISK, chairman of Amalgamated Wireless (Australia), was the guest of honour at



H. Bishop, who succeeds Sir Noel Ashbridge as B.B.C. Controller of Engineering.



Come lovely Flowers

And so it is that from the darkness of the present hour will emerge a brighter day when the brain and brawn of modern industry will be utilised in further peacetime products and pursuits. While serving the Government to-day we are broadening both creative and manufacturing possibilities for a happier world to-morrow. Astatic engineers are available to work in co-operation with electronic engineers in the development of new wartime equipment, especially as it may have to do with pickup and transmission of sound. Astatic crystal microphones, pickups, cartridges and recording devices will be available again for your use when those brighter days are here. Register your name with our Representative for your future benefit.

ASTATIC

THE ASTATIC CORPORATION
YOUNGSTOWN, OHIO, U.S.A.
TORONTO, CANADA.

Exclusively Represented by

Frank Heaver Ltd. Kingsley Road,
Bideford, N. Devon.

CROWNAME

RADIO COMPONENTS

THE radio industry is contributing its share towards the assurance of a free world. As a part of that industry, CROWE will continue its peacetime leadership when the assurance is won.



CROWE NAME PLATE AND
MANUFACTURING CO.
CHICAGO, ILL. U.S.A.

Exclusively Represented by

Frank Heaver Ltd. Kingsley Road,
Bideford, N. Devon.

World of Wireless—

the August luncheon of the Radio Industries Club. Speaking of the development of beam transmission between Great Britain and Australia, he stressed the need for the development of communication systems within the British Empire.

Australia's two broadcasting systems, the National Service, based on the B.B.C., and the Commercial Service, operated by private enterprise and financed by advertisement revenue, include 140 comparatively low-powered transmitters. Sir Ernest gave the latest figure of Australia's licence holders as 1,500,000, each of whom pays £1 per annum.

NEWS IN MORSE

A REVISED schedule of transmissions of official news bulletins radiated in morse from the G.P.O. stations has been received since that published last month. Although intended for oversea listeners, the transmissions may be heard in this country. The call signs and the wavelengths employed are:—

GAA	14.72m	GCP	27.86m
GIA	15.27	GIH	28.17
GAD	15.40	GAY	33.67
GID	22.13	GBC5	34.56
GIM	23.13	GIJ	42.95

The times (GMT) of the broadcasts and the call signs of the transmitters radiating them are:—

- *0045: GBC5, GIJ.
- 0830: GIA, GID, GIH.
- 1302: GAD, GIA, GID.
- 1602: GAD, GIA, GID.
- 1800: GIM, GCP, GAA.
- *2000: GIM, GBC5.
- 2330: GAY, GIH

Transmissions marked with an asterisk are continuations of the preceding broadcasts.

The B.B.C.'s morse transmissions of news in English are now radiated from 0045 to 0100 (GMT) on seven wavelengths in the 49- and 41-metre bands.

RADIO OFFICERS' BRAVERY

THE Lloyd's Medal for bravery at sea has been awarded to Radio Officer George Kenmure Garstin. Although it was obviously only a matter of minutes before his ship, which was torpedoed whilst sailing in convoy to Russia, would sink, Radio Officer Garstin, having heard the order to abandon ship, refused to leave the wireless cabin until he was satisfied that the messages he had sent out for help had been received. The Medal was also awarded posthumously to Third Radio Officer Richard Phillips, who lost his life in rescue attempts after he had succeeded in getting a portable transmitter into a lifeboat.

BRIT. I.R.E.

SIR LOUIS STERLING presided at the annual general meeting of the British Institution of Radio Engineers held on September 3rd

(not 16th, as stated last month).

At the conclusion of the business Sir Ernest Fisk, first president and immediate past-president of the Institution of Radio Engineers of Australia, addressed the meeting. He gave an interesting survey of the history of wireless telegraphy and broadcasting from the beginning of the century, describing some of the technical and prejudicial difficulties that had to be overcome before direct Empire communication, so essential to Australia, could become an accomplished fact.

He said he looked forward to the time when the two Institutions could work in co-operation.

U.S. SHORT-WAVE STATIONS

PERMISSION has been granted the World Wide Broadcasting Foundation of Boston, Mass., to erect two new short-wave transmitters at Scituate, Mass. Like the existing World Wide transmitters WRUL, WRUW and WRUS, and, in fact, all short-wave stations in the States, the new transmitters will be operated by the owners, but the programmes will be supervised by the Office of War Information.

Call signs have not yet been allocated to these latest outlets for the "Voice of America," which will operate on 6.04, 9.70, 15.35, 17.75 and 21.46 Mc/s.

New Radio-phototelegraphic Service.—It is announced by Cable and Wireless that a phototelegraph service between London and Sweden commenced on August 21st last.

B.B.C. Short-wave Bulletins.—Various short-wave services of the B.B.C. are being increased as the tempo of the war quickens. The latest list includes transmissions in 49 languages. The following schedule of transmissions of news in English on short waves will be in use from September 26th. Times are given in BST.

0015†	0045†	0206	0345	0530	0605	0715	0830	0900	1200	1400	1600	1700	1900	2045	2145	2245†	2300	2345
	25.53, 25.68, 30.53, 31.32.		25.68, 30.53, 30.96, 31.32, 41.96.	42.13, 42.46, 48.43, 49.10.	49.91, 25.47, 25.53, 25.68, 30.53, 31.25, 31.32, 31.55, 42.13.	19.66, 19.91, 25.47, 25.53, 25.68, 31.25, 31.32, 31.55, 42.13.	16.92, 19.60, 19.66, 19.91, 25.47, 25.53, 25.68, 30.53, 31.55, 42.13.	24.80, 25.58, 31.12, 31.25, 31.61, 31.75, 31.88, 41.01, 41.32, 41.96; 42.46, 48.43, 48.98, 49.50.	13.97, 16.64, 16.79, 16.84, 19.44, 19.60, 19.91, 25.53.	13.97, 16.64, 16.79, 16.84, 19.44, 19.46, 19.60, 19.91, 24.92, 25.68, 31.55.	16.59, 16.64, 16.92, 19.60, 19.66, 25.53.	16.92, 19.60, 19.66, 19.82, 25.29, 25.53, 31.25, 42.46.	16.92, 19.60, 19.66, 25.53, 31.25.	16.94, 25.29, 30.53, 31.41, 31.55, 31.88, 41.49, 41.75, 41.96, 42.46, 48.98, 49.42, 49.92.	25.53, 25.68, 30.53, 31.32.	31.25, 42.46.	25.53, 25.68, 30.53, 31.32.	

† Sundays only. ‡ Sundays excepted.

Institution of Electrical Engineers.—The Wireless Section of the Institution is holding its first meeting of the new Session at 5.30 on Wednesday, October 13th, when T. E. Goldup, chairman, will present his inaugural address. An informal meeting of the Institution will be held at 5.30 on Monday, October 25th, when the president will open a discussion on "How Far is International Standardisation in the National Interest?"

I.E.E. Students' Section.—Officers elected for the 1943-1944 Session of the London Students' Section of the Institution are as follows: J. D. McNeil, chairman; C. C. Barnes, vice-chairman; H. Shorland, hon. secretary; B. Rosenblum, hon. assistant secretary.

Waste Paper.—The salvaging of waste paper is still a national necessity. During the first six months of this year fifty-seven tons of waste paper were salvaged by the main branches of the B.B.C. Strict economy by the Corporation in the use of new paper has resulted in a substantial saving of new supplies.

"News in English from Abroad."—It is regretted that pressure on our space this month has necessitated this regular feature being held out.



R. T. B. Wynn, the new Assistant Controller (Engineering Division) of the B.B.C.

IN BRIEF

Receiving Licences.—In Great Britain and Northern Ireland the total number of receiving licences is now well over 9,250,000.

In Sweden the number of wireless licences at the end of June was 1,670,188, that is, 259 licences per 1,000 inhabitants.

ERRATUM

"Wide-range R-C Oscillator"; September issue.

The expression $\sqrt{2.R}$ (p. 263, 9th line from bottom of col. 3) should read $\sqrt{2.R}$; the square root sign applies only to the figure 2 and not to R.

Letters to the Editor

Contrast Expansion and Distortion. Pick-up "Tracking Arms"

Contrast Expansion

IN discussions of the objects and drawbacks of automatic compression followed by expansion, it is desirable to distinguish between two classes of communication systems.

In one class, any transgression of a certain output level incurs the immediate penalty of non-linear distortion. This class includes amplitude - modulated carrier systems, and systems in which one link such as a power valve may overpass the limits of its linear action.

In a second class, a level exists, below the distortion level, which may be exceeded occasionally without penalty, provided that the practice does not, so to speak, become a habit.

This earlier restriction may be imposed by cross-talk into adjacent lines, or by the heat dissipation of valves. In frequency-modulated carriers, an occasional splash into a neighbouring frequency band may be permitted, provided that it occurs rarely. In lateral gramophone recording, a rather wider swing is permissible to the groove, if the chance of a wide swing on the neighbouring grooves is small. It is in systems of the latter class that distortionless "compansion" becomes possible and useful. If the compressor and expander circuits have equal responses both in phase and amplitude, they will together introduce no distortion of any sort into the system, and will escape the objections of Mr. Hughes in his letter of July, 1943.

I have had experience of such a system in a gramophone recorder and reproducer. I found a short time-constant of the order of 30 milliseconds suitable both for onset and recovery.

As a footnote, I would like to express my disillusionment with automatic contrast expansion used otherwise than with a few selected records, or with records made with a compressor the inverse of the expander. The most unhappy results are obtained

when attempting to undo the work of a control engineer who has brought up the gain during a quiet passage to unity signal/cough ratio.

C. E. G. BAILEY.

Mullard Radio Valve Company,
London, W.C.2.

IT seems rather regrettable that the present correspondence on volume expansion has produced so little "meat," while the letter from J. R. Hughes only serves to increase the confusion. It is accepted that a good volume expander greatly enhances the dramatic appeal of a suitable recording and that surface noise is considerably reduced, but Mr. Hughes appears to believe that the distortion introduced on transients is such a disadvantage that volume expanders are not worth while.

Mr. Hughes does not produce any data to support this last point (in fact such data is not available), but attempts to decry the value of judgment tests with a lot of vague statements that listening tests of this type are unsatisfactory. Judgment tests form the backbone of any method of assessing sound quality and are in widespread use by all the research laboratories engaged on acoustical development. When put to critical test they have shown surprising agreement. With five minutes' thought, I found it possible to write down twelve different types of distortion that an electro-acoustical system might introduce. Quantitative data on the quality deterioration introduced is available on only three of the twelve. In the present stage of the art there is therefore no means of assessing quality other than the use of judgment tests.

The ideal is well known (Mr. Hughes, paragraph 5) but it cannot and never will be obtained, and it becomes necessary to find out what departures from perfection are permissible before the ear detects the departure. This is plain common sense.

Regarding transient distortion,

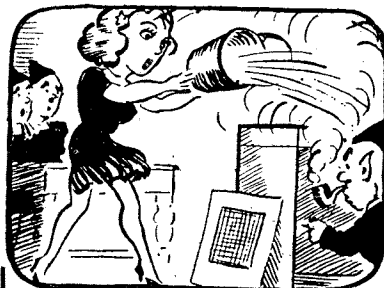

THE "FLUXITE QUINS" AT WORK

*One day young OO had a fright,
Thought the radio set was alight,
With unerring aim
She extinguished the flame
(And old EH—mending wires—with Fluxite.)*

See that FLUXITE is always by you—in the house—garage—workshop—wherever speedy soldering is needed. Used for over 30 years in Government works and by leading engineers and manufacturers. Of all Ironmongers in tins, 8d., 1/4 and 2/8.

Ask to see the FLUXITE SMALL-SPACE SOLDERING SET—compact but substantial—complete with full instructions, 7/6.

TO CYCLISTS! Your wheels will NOT keep round and true unless the spokes are tied with fine wire at the crossings AND SOLDERED. This makes a much stronger wheel. It's simple—with FLUXITE—but IMPORTANT.

The FLUXITE GUN puts FLUXITE where you want it by a simple pressure
Price 1/6, or filled, 2/6.

ALL MECHANICS WILL HAVE



FLUXITE

IT SIMPLIFIES ALL SOLDERING

Write for Book on the ART OF "SOFT" SOLDERING and for Leaflets on CASE-HARDENING STEEL and TEMPERING TOOLS with FLUXITE. Price 1d. each

FLUXITE LTD.

(Dept. W.W.), Bermondsey Street, S.E.1.

Letters to the Editor—

I have said that the distortion may be there, but is so small that it is absolutely indistinguishable on the vast majority (99 per cent.) of records. The surface noise reduction is a real advantage and is clearly apparent on every record, while the increase in dynamic range is surprising on at least 50 per cent. of the records.

Complete quantitative data on the effect of small transient distortions is lacking but the two following items are of some value.

On looking back over my pre-war results I note that on a volume expander designed in 1936, I found that at 400 cycles the 2nd harmonic was 52 db. and the 3rd harmonic 40 db. down on the fundamental. To express the transient distortion is more difficult. One might express this mathematically as the output voltage obtained from an input Heaviside function, or one might portray the output wave graphically, but there is no method of correlating this with "how does it sound." Regrettable, but that is the present position. Judgment tests were very favourable, as mentioned in my first letter.

Volume expanders can be built with an "opening time" of 10 milliseconds, and a "closing time" of 1 to 2 seconds without any particular difficulty, and I am afraid that it never occurred to me to design expanders with other than unequal opening and closing times.

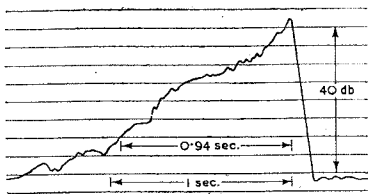

Mr. Hughes does not seem to like this, but perhaps he will tell us which instrument produces a sudden decline in power output and after that, what he thinks will happen in any room in which it is played. The accompanying record, taken with a high speed recorder in my room (14ft. x 12ft.), represents the 256-cycle note on the piano, sounded for as short a period as I was able. It will be seen that, starting from the right, the rate of rise is limited by the recorder characteristic (300 db/ sec.) but a 30-db

decay requires a period of 0.94 sec. This is the justification for rapid opening and long closing times in expander circuits.

Regarding the suggested method of introducing non-linear distortion (final paragraph of Mr. Hughes' letter) as an alternative to amplitude control, a little consideration will show that if this is applied to a volume compressor/expander circuit using an auxiliary control tone (the probable solution for sound film) the phase characteristic requirements of the system become impossible of attainment, while if the standard expander types are used, the overall distortion is likely to be tremendous owing to the difficulty with the frequency characteristic of the transmission channel.

In conclusion, volume expanders are not without their disadvantages (like any car) but so far nobody has mentioned them. I rather suspect that the critics have little practical experience.

Rugby

J. MOIR.

Pick-up Mounting

IN the recent correspondence on gramophone pick-ups the pivoting systems for the tracking arms were usually not described, and at least one writer was having trouble on this account. Since the discussion died down I have evolved what appears to be as simple and satisfactory a construction as possible, and it is described below.

The tracking arm is of $\frac{1}{2}$ in. copper tubing bent into an "S" shape to secure the best tracking conditions. At the bearing end a $1\frac{1}{2}$ in. length of bicycle spoke is soldered transversely through the tube. This forms the bearing pin, and it rotates in two $\frac{3}{8}$ in. bearings. These are carried on a sheet-brass yoke, which is sweated to a $\frac{3}{8}$ in. length of $\frac{3}{8}$ in. rod which is carried on a $\frac{1}{16}$ in. steel ball, forming a footstep bearing in the mounting pillar.

Since the arm is counter-balanced the pressure on the walls of the traversing bearing is always small and the stiffness slight. The frictional effects caused by the bearing using the cycle spoke are also slight because of the small diameter of the pin.

Satisfactory connection for the earthy side of the circuit is made through the footstep bearing. A short coiled length of No. 28

SWG wire is used for the live side.

There is practically no slackness in the system as a whole and the pick-up tracks satisfactorily on all records with a 12-gm. needle-tip pressure.

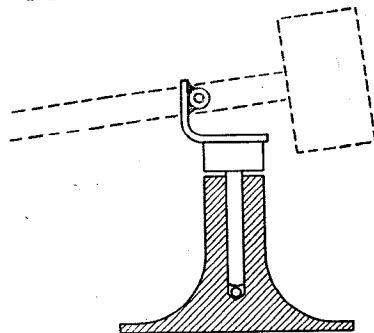

It has been suggested that the torsional resonance of the tracking arm is least when the arm is as low as possible. There is a further means of reducing the resonance. If the axis of the arm passes through the point of contact of the needle with the record there is no torque applied to the arm. This condition can be approached by sloping the tracking arm downwards towards the pick-up head so that its axis passes as near the needle tip as possible.

Finally, I would draw attention to my use of the term "tracking arm," which I consider more suitable than the title "carrying arm" suggested by Mr. Aldous.

A. C. ROBB.

Upton, Ches.

Wire or Wireless?

IN your September issue, under the heading "Against Wire Broadcasting," you state that "most wireless men object to a system that threatens the expansion of their technique."

Surely this statement cannot be applied to wired broadcasting.

In the system of wired broadcasting developed by the G.P.O. and described by Dr. Walmsley in the *Journal of the Institution of Electrical Engineers*, provision was made in the design of the apparatus used at the subscribers' end for the receiving of programmes sent out by means of wired broadcast and also for the reception of radiated programmes.

The inference is that wired broadcast is not intended to replace radiated programmes, but is there as an alternative, to be

used at the discretion of the subscriber.

It appears, therefore, that far from threatening the expansion of wireless technique, wired broadcasting opens up opportunities for the expansion of development in existing fields, and also opens new fields for the research into and development of wired broadcast systems.

The set manufacturers who, as stated, represent 80 per cent. of the wireless industry, would be called upon to develop receivers capable of receiving both radiated and wired broadcast programmes.

The firms representing the other 20 per cent. would have, in addition to their existing work, the development and manufacture of the apparatus required for wired broadcasting, i.e., transmitters, carrier frequency amplifiers, etc.

RALPH T. LAKIN.

Mansfield, Notts.

AS a keen radio man—but not at all interested in the economic welfare of the radio manufacturer—I feel the point of view of the quality enthusiast has not been sufficiently stressed in the “wire versus wireless” controversy.

A wired carrier-current system would seem definitely to offer the ideal means of meeting our requirements for modulation frequencies up to at least 15 kc/s with high signal/noise ratio and freedom from the defects and irritations of the purely radio path—interference, heterodynes, selective fading, etc.

The one danger with wired broadcasting seems to be the attempt to provide too many channels. Eckersley has proposed six—surely unnecessary!—with modulation frequencies up to 8 kc/s; while admitting that the quality would be as good, probably better, than most commercial receivers provide at the present, I should be dead against such a limitation of frequency range. Reduce the number of channels and allow us at least one high quality signal covering programmes free of recorded matter and bad land lines.

That high quality is appreciated even by the uninitiated is easily shown, and I think that on this score alone, a special service of a single channel of this nature is worthy of consideration and the

results, provided always, of course, that the terminations did it justice, would be a self-advertisement.

R. W. BATT.

Cosham, Hants.

“CONTRAST EXPANSION UNIT”

IN the article under this title by D. T. N. Williamson in the last issue the diagram (Fig. 4) showing the waveform of a struck string was inadvertently reversed; the maximum amplitude should have appeared at the left of the diagram, thus:—

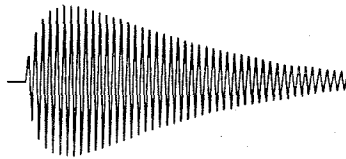

Fig 4

At the same time we are taking the opportunity of redrawing Figs. 2 and 3 to bring out the essential points of the author's original drawings more clearly. Fig. 2 (b) should have shown the original contrast of (a) at the instant of amplitude increase (the expansion being additional to this).

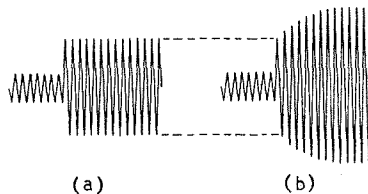

Fig. 2

Similarly, Fig. 3 should show the initial change in amplitude followed by a further reduction under the influence of a long time constant.

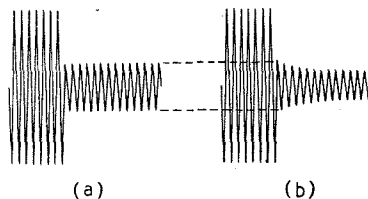
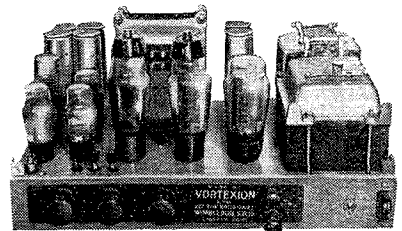

Fig. 3

In Fig. 7 the electrolytic condenser C10 should be connected with its positive terminal to chassis and negative to the junction of R17 and R18. Also the resistance next to the cathode of V1 should be R2 and not R4.

The Improved
VORTEXION
50 WATT
AMPLIFIER CHASSIS



The new Vortexion 50 watt amplifier is the result of over seven years' development with valves of the 6L6 type. Every part of the circuit has been carefully developed, with the result that 50 watts is obtained after the output transformer at approximately 4% total distortion. Some idea of the efficiency of the output valves can be obtained from the fact that they draw only 60 ma. per pair no load, and 160 ma. full load anode current. Separate rectifiers are employed for anode and screen and a Westinghouse for bias.

The response curve is straight from 200 to 15,000 cycles. In the standard model the low frequency response has been purposely reduced to save damage to the speakers with which it may be used, due to excessive movement of the speech coil. Non-standard models should not be obtained unless used with special speakers loaded to three or four watts each.

A tone control is fitted, and the large eight-section output transformer is available in three types: 2-8-15-30 ohms; 4-15-30-60 ohms or 15-60-125-250 ohms. These output lines can be matched using all sections of windings and will deliver the full response to the loud speakers with extremely low overall harmonic distortion.

PRICE (with 807 etc. type valves) **£18.10.0**
Plus 25% War Increase

MANY HUNDREDS ALREADY IN USE
Supplied only against Government Contracts

VORTEXION LTD.

257, The Broadway, Wimbledon, S.W.19

Phone: LIBerty 2814

RANDOM RADIATIONS

By "DIALLIST"

The Daniell

THE suggestion made by a *Wireless World* Brains Trustee that the factor eleven in the 132 kV of the grid power lines can be traced back to the 1.1-volt EMF of the Daniell cell is interesting and I have an inward feeling that he may be right. Only one thing is against it and that is that 132 kV is the voltage of power lines in one or two other countries. Had this figure been used in Britain alone, I'd have swallowed the Daniell explanation hook, line and sinker. The Daniell certainly was in use before the volt came along and persisted for some time afterwards. I'm sure I can remember seeing it in old books on electricity. It may well have lingered on even amongst technicians, for we have a national fondness for retaining weird, out-of-date units such as "hand," "cran," "sitting," "chaldron," "leash" and "square." Even the "league" as a measure of distance remained in regular use until comparatively recent times. Do you remember Jules Verne's *Journey to the Centre of the Earth*? I seem to recall that the professor in that highly imaginative work made electrical apparatus, containing a Rumkorff coil, which produced a pressure of a vast number of Daniells. If the Daniell was an accepted measure of EMF in Jules Verne's time, it might easily have been used in the calculations of those who designed and laid out the earliest electricity supply systems. On this hypothesis our Grid voltage is really 120 kilodaniells (help!) and the round figures of which we are all so fond are preserved beneath the overlying crust of the volt.

And the Hertz

What has happened to the Hertz, meaning a cycle-per-second? It seems to have dropped out of use altogether. When the first of the great Plans (the Geneva, wasn't it?) for ending Europe's broadcasting chaos was adopted the ultra-correct B.B.C. always gave the frequencies in kilohertz in all the station-lists that it published. The man-in-the-street much preferred the wavelengths, in which he has been brought up, to the (to him) new-fangled frequencies. So far as he swallowed the latter at all, he swallowed them in kilocycles and would have nothing to do with kilohertz. Some rather pedantic technical authors strove to uphold

the Hertz and its various compounds, but others were content with kilocycles-per-second. Nowadays most people say and write just kilocycles or megacycles, though the "per-second" part is retained in the written abbreviations always used, kc/s and Mc/s. Hertz did such wonderful pioneer work in wireless that it seems a pity that his name cannot be commemorated by a wireless unit of measurement. Curious— isn't it?— that to achieve the spelling of your name with a small letter is one of the highest pinnacles of scientific fame?

□ □ □

Utility Sets

ONE correspondent writes that he couldn't disagree with me more over what I wrote recently on the subject of utility sets. After reading his letter carefully I can't quite make out why! He is a quality enthusiast; so am I. He feels that the manufacturers have in the past taken the wrong line by emphasising the station-getting powers of their sets in their advertisements and so on; so do I. He wants an adequate number of new receivers to be available as soon as possible to the public; I want the same thing. Where, perhaps, we do differ is in two points, not, so far as I can recall, mentioned in my notes, but stressed in his letter. My correspondent thinks that (a) now is the time to educate the public up to high-quality reception, and (b) that it is possible to produce low-priced utility receivers that will give such quality. I can't see eye to eye with him in either of those contentions. At the moment the majority of listeners seem to desire two things mainly from their wireless sets: news and light entertainment. And for neither of these is high-quality reception of paramount importance. If you want proof that quality doesn't matter—that it is actually repugnant to the tastes of most of those who listen to dance bands and such-like, observe the setting of their tone controls when modern music is coming in. In an least eight cases out of ten you'll find that such "top" as the set may have—and that often isn't much—has been removed in order to produce the mellow (i.e., topless) reproduction that seems essential to palliate the horrid noises made by muted trumpets, jazz clarinets and other queer instruments, including the strident female crooner.

In Self-defence

Speaking of crooners reminds me that that eminent critic Mr. James Agate has offered an explanation of the reason why they use microphones when performing on the stage before an audience. I'd always thought that it was due to the fact that their bleating voices were too feeble to fill an auditorium of any size. Mr. Agate has come to a different conclusion. Most of them, says he, become known to the great mass of the people by their broadcasting. Those who hear them use receiving sets either inherently incapable of good quality, or so "toned down" that the reproduction is queerly distorted. Having heard crooners and other alleged singers under these conditions, they conclude that this is what their efforts really sound like. If they went to theatres and heard their favourites performing without distortion introduced, wilfully or incidentally, by microphone, amplifier and loudspeaker, they would feel that something was lacking and would be disappointed. In other words, they have come to prefer the distorted sounds associated with "canned" music to the real thing.

The Price of Quality

Few, I think, will agree with my correspondent's second contention: that you can mass-produce quality receivers at a low price under wartime conditions. The average purchaser doesn't realise that whilst it is a comparatively inexpensive business to turn out sets that will bring in lots of stations, the bits and pieces necessary for good-quality reproduction are far from being cheap or easy to make. It's the AF side of the set that eats up the money, unless you are content to put up with a fair amount of distortion. My own feeling is that whilst the war is on it is best to accept moderate quality of reproduction—just as we accept moderate quality in so many other things—in order to be able to satisfy the big demand for new sets to replace those that are worn out and beyond repair. Broadcast reception is a necessity rather than a luxury in the wartime home, and the only way to enable as many as possible of our nine million licensed listeners to have it is to ensure a regular supply of new sets, sufficient to replace the old ones that pass out. In present circumstances there would seem to be no means

of doing this unless the new sets are of simple type and made up of more or less standard parts. Therefore I support the utility set—but as an emergency measure only.

□ □ □

Post-war Channels

WHETHER or not wired broadcasting is developed as a competitor of the existing wireless variety there is little doubt that the medium- and long-wave stations of Europe will continue their activities for some time after the blessed return of peace. And what a grand opportunity there will be to settle the allocation of broadcasting channels on a rational basis. The last pre-war plan continued the 9-kilocycle separation between channels on the medium-wave band and adopted something even smaller on the long waves, if my memory isn't at fault. Now a separation of 9 kc/s is not enough if receiving sets are to reproduce speech and particularly music with good quality. We can't do with less than 10 kc/s, and we must see that it is adopted. The 9-kc/s basis was agreed upon because in those rather turbulent times nothing better could be done.

What Separation ?

As I've said, 10 kc/s is the smallest channel separation that is going to be satisfactory from the quality point of view. We know that it is possible to fit in large numbers of stations on a 10-kc/s basis if there is a supervising authority armed with real powers, for it has been done with most satisfactory results in the U.S.A., where the Federal Communications Commission can and does enforce its decisions, banishing recalcitrant stations from the ether if need be.

And there is another reason why the 10-kc/s separation is so much to be desired. The broadcasting bands divide themselves automatically in the most convenient way. On the medium-wave band we have channels on 550, 560, 570 kc/s and so on up to 1,500: there are no odd kilocycles or decimal parts of kilocycles to remember. And we can leave out the final nought in every case, calling them simply channels 55, 56, 57 and so on. Not only are these easy to remember, but they also make the calibration of broadcast receiver dials simplicity itself. American receivers made for home use are often calibrated in this way. It is rare to hear wavelengths mentioned by Americans when speaking of their broadcasting stations: they find channel No. 72 much easier to remember than 416.6 metres.

COMMUNICATIONS DEPEND...



ON SMALL PARTS...

In countless instances quite intricate pieces of apparatus are wholly dependent on the proved reputation and reliability of their component parts.

All products from the House of Bulgin are pre-eminent for superior design and workmanship and every article bearing our Trade Mark has to pass exacting and exhaustive tests during the course of its production.

We ask the kind indulgence of the Trade on delivery until peaceful conditions return.

*The Choice
of Critics*

BULGIN

FOR

TRANSFORMERS

THE largest and most extensive range of midget and ultra small intervalve (voltage) transformers in the world. Provided with high- μ cores and carefully proportioned windings of finest enamelled-copper wires. All joints welded; mono-metallic from start to finish for long life under all conditions.

"The Choice of Critics"

BULGIN

REGISTERED • TRADE • MARK

A. F. BULGIN & CO. LTD., BYE PASS RD., BARKING,

TEL.: RIPPLEWAY 3474 (4 lines).

ESSEX

RECENT INVENTIONS

HEARING-AID AMPLIFIERS

THE diagram shows a portable microphone set in which negative feedback is used to ensure fidelity, and positive feedback to counteract the loss in gain as the battery runs down. Provision is also made to adapt the tonal response of the microphone to meet high or low levels of local noise.

Both the microphone M and the receiver Q are preferably of the piezoelectric type. A tapping P from a resistance shunting the output transformer T applies negative feedback (a) through a resistance R, condenser C and resistance R₁ to the grid of the last amplifier V₃, and (b) through resistances R₂, R₃ and a condenser C₁ to the screen grid of the first amplifier V₁. As the resistance of battery HT increases, a proportional positive feedback is applied to the grid of the valve V₂ through a resistance R₄ and the condenser C₂. It will be observed that

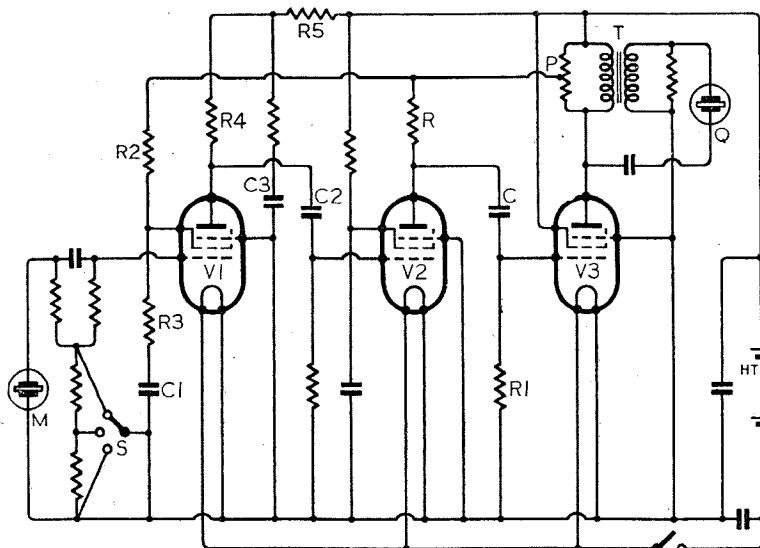

Battery amplifier with gain compensation.

the resistance R₄ is in the anode circuit of V₁, and is also in series with the normal decoupling circuit R₅, C₃ of the battery. A switch S allows the frequency response of the microphonic input to be varied to suit the personal needs of the user or to counteract abnormal local conditions.

Western Electric Co., Inc. Convention date (U.S.A.) December 24th, 1940. No. 552331.

ELECTRO-MECHANICAL METERS

VARIATIONS of mechanical force are converted into equivalent voltages and are measured by a valve the gain of which is automatically controlled to give a straight-line law as between the mechanical and electrical values.

For instance, the pressure inside the cylinder of an internal combustion

A Selection of the More Interesting Radio Developments

engine is applied to a diaphragm forming one plate of a variable condenser, which, in turn, constitutes one of the arms of a capacity bridge. High-frequency oscillations are applied to one diagonal of the bridge, and a voltage modulated in accordance with the pressure variations is taken from the other diagonal and applied to the grid of a pentode amplifier. The output from the amplifier is fed to a diode from which a negative feedback is applied to control the gain of the amplifier so that the original non-linearity of the condenser response is corrected.

Philips Lamps, Ltd. Application date September 19th, 1941. No. 552098.

RADIO ALTIMETERS

THE distance of a reflecting body can be measured by noting the time taken by a reflected radio wave to return to its point of origin. One known method of ascertaining the required time interval, which is of the order of microseconds, is to vary the frequency of the outgoing wave over a constantly repeated cycle, and to measure the beat-frequency set up between the outgoing and returning waves. Usually the same aerial serves both for transmission and reception.

In practice, the aerial tuning is fixed to coincide with the middle frequency of the repeated cycle. This means that the efficiency of the system necessarily falls off towards both extremes of the frequency sweep.

In the present arrangement tuning of the aerial is linked through ganged condensers with the circuits of the carrier-wave generator, so that the exploring wave is radiated at maximum efficiency at all times. Since the difference between the highest and lowest operating frequency is only a small percentage of the carrier frequency, the small amount of detuning experienced by the incoming reflected wave is immaterial.

Standard Telephones and Cables, Ltd., and E. O. Willoughby. Application date September 26th, 1941. No. 552260.

SIGNAL-TO-NOISE RATIO

THE total "noise energy" in the circuits of a receiver is proportional to the product of the power of the noise and time during which it persists. Accordingly if a receiver is made active only at intervals of, say, 1/5,000 of a second, repeated 500 times a second the resulting noise will be reduced by approximately ten-to-one in power. This will not, of course, improve the signal-to-noise ratio when receiving continuous signals.

If the outgoing signal is radiated in intermittent pulses, it can be transmitted at a much higher level of instantaneous or "peak" power than possible for sustained or continuous operation. If the intermittent activities of the transmitter and receiver are synchronised a considerable improvement in signal-to-noise ratio is achieved, and this can be still further improved by the use of directive aerials.

The specification describes a system of pulsed transmission and reception which embodies the above-mentioned principle.

Marconi's Wireless Telegraph Co., Ltd. (Assignees of C. W. Hansell). Convention date (U.S.A.) December 27th, 1940. No. 552482.

CATHODE-RAY TUBES

THE fluorescent screen of a cathode-ray tube is laid directly on the inside wall of the glass bulb, the usual intervening layer of transparent metal being omitted. Its place is taken by coating the corresponding part of the external glass with a thin layer of gelatine containing lithium chloride or an electrolyte, such as phosphoric acid. This is covered, in turn, by a protective layer of transparent lacquer.

The arrangement prevents distortion due to external fields and allows, say, an oscillograph trace to be measured by a pair of callipers without hand-capacity effects, or a television picture to be closely examined without being distorted by the breath of an observer.

Philips Lamps, Ltd. (communicated by N. V. Philips Gloeilampenfabrieken). Application date October 14th, 1941. No. 552173.

The British abstracts published here are prepared with the permission of the Controller of H.M. Stationery Office, from specifications obtainable at the Patent Office, 25, Southampton Buildings, London, W.C.2, price 1/- each.